

Programmable AC/DC Power Source

APS-1102

USER MANUAL

GW INSTEK PART NO. 82PS-11020M01



ISO-9001 CERTIFIED
MANUFACTURER

GW INSTEK

This manual contains proprietary information, which is protected by copyrights. All rights are reserved. No part of this manual may be photocopied, reproduced or translated to another language without prior written consent of Good Will company.

The information in this manual was correct at the time of printing. However, Good Will continues to improve products and reserves the rights to change specification, equipment, and maintenance procedures at any time without notice.

— Preface —

Thank you for purchasing the **APS-1102 programmable AC/DC power source**.

To ensure safe and proper use of this electric equipment, please read first **Safety Precautions** on the following pages.

■ Caution Symbols Used in This Manual

The following caution symbols are used in this manual. Be sure to observe these caution symbols and their contents to ensure the safety of the user and avoid damage to the equipment.

WARNING

This mark indicates information for the avoidance of a hazard such as electric shock that may endanger human life or cause injury during handling of the equipment.

CAUTION

This mark indicates information for the avoidance of damage to the equipment during handling.

- This manual has the following chapter organization.

If reading this manual for the first time, start from **1. OVERVIEW**.

1. OVERVIEW

Briefly describes and explains the features, applications, and functions as well as brief operation principles of the APS-1102.

2. PREPARATIONS BEFORE USE

Describes various cautions regarding preparations to be made before using the APS-1102, ranging from installation to connection of the power supply.

3. PANEL AND BASIC OPERATIONS

Describes the functions and actions of the panel controls and their basic operations. Read this chapter while operating the APS-1102.

4. ADVANCED OPERATION EXAMPLE

Describes how to use advanced functions.

5. MENUS

Explains the LCD screen configuration and setting items of each menu.

6. USB INTERFACE

Describes the commands for controlling the APS-1102 via the USB interface.

7. TROUBLESHOOTING

Describes error messages and handlings when problems occur.

8. MAINTENANCE

Describes basic operation tests and daily maintenance procedures.

9. SPECIFICATIONS

Lists the specifications (functions and performance) of the APS-1102.

— Safety Precautions —

To ensure safe use, be sure to observe the following warnings and cautions.

Good Will shall not be held liable for damages that arise from a failure to observe these warnings and cautions.

This product is a Class 1 product (with protective conductor terminal) that conforms to the JIS and IEC insulation standards.

- **Be sure to observe the contents of this user manual.**

This user manual contains information for the safe operation and use of this product.

Be sure to read this information first before using this product.

All the warnings in the user manual must be heeded to prevent hazards that may cause major accidents.

- **Be sure to ground the product.**

This product uses a line filter and must be grounded to avoid the risk of electric shock.

To prevent electric shock, be sure to safely implement grounding according to Japanese Standard for Electrical Equipment Technology D (100 Ω or lower) or higher.

The APS-1102 is automatically grounded when the 3-prong power plug is connected to a 3-prong power outlet with a protective grounding contact.

This product does not come with a 3-prong to 2-prong conversion adapter. When using a separately sold 3-prong to 2-prong conversion adapter, be sure to connect the grounding wire of the adapter to the grounding terminal next to the outlet.

- **Check the power supply voltage.**

This product operates on the power supply voltage indicated in Grounding and Power Supply Connection in this user manual.

Prior to connecting the power supply, check that the voltage of the power supply matches the rated power supply of the product.

- **In case of suspected anomaly**

If this product emits smoke, an abnormal smell, or abnormal noise, immediately power it off and stop using it.

If such an anomaly occurs, do not use this product until it has been repaired, and immediately report the problem to the location of purchase (either Good Will or your distributor).

- **Do not use this product when gas is present.**

An explosion or other such hazard may result.

- **Do not remove the cover.**

This product contains high-voltage parts. Absolutely never remove its cover.

Even when the inside of this product needs to be inspected, do not touch the inside. All such inspections are to be performed by service technicians designated by Good Will.

- **Do not modify this product.**

Absolutely never modify this product, as this may cause new hazards and may disqualify this product from repair in case of failure.

● Prevention of electrical shock due to output voltage

The maximum output of the APS-1102 is ± 400 V.

Carefully operate the APS-1102 to avoid electrical shock.

Directly touching the output or changing cable connections while output is on may cause electrical shock.

● Safety-related symbols

The general definitions of the safety-related symbols used on this product and in the user manual are provided below.



User Manual Reference Symbol

This symbol is displayed to alert the user to potential danger and refer him/her to the user manual.



Electric Shock Danger Symbol

This symbol indicates locations that present a risk of electric shock under specific conditions.



Protective Ground-Terminal Symbol

This symbol identifies a pin that must be grounded to avoid electric shock. Before operating the device, be sure to safely implement grounding according to Japanese Standard for Electrical Equipment Technology D (Type 3, 100 Ω or lower) or higher.



Warning Symbol

This symbol indicates information for avoiding danger to human life or bodily injury while handling this product.



Caution Symbol

This symbol indicates information for preventing damage to the product when handling it.

● Other symbols



This symbol indicates the “on” position of the power switch.



This symbol indicates the “off” position of the power switch.



This symbol indicates that the external conductor of the connector is connected to the case.



This symbol indicates that the external conductor of the connector is connected to the signal ground.

● Waste disposal

To help ensure environmental protection, please note the following precautions regarding disposal of this product.

<1> This product contains a lithium battery.

<2> The LCD backlight unit contains mercury.

<3> Use a professional industrial waste contractor to dispose of this product.

Contents

	Page
Preface —.....	i
Safety Precautions —.....	ii
1. OVERVIEW.....	1-1
1.1 General.....	1-2
1.2 Features	1-2
1.3 Applications.....	1-3
1.4 List of Functions	1-4
1.5 Operation Principles	1-6
2. PREPARATIONS BEFORE USE.....	2-1
2.1 Checking Before Use	2-2
2.2 Installation Environment.....	2-3
2.3 Grounding and Power Supply Connection	2-5
2.4 Simple Operation Checks	2-8
2.5 Calibration	2-10
3. PANEL AND BASIC OPERATIONS.....	3-1
3.1 Panel Components and Operations	3-2
3.1.1 Operation panel.....	3-2
3.1.2 Front panel	3-3
3.1.3 Rear panel	3-4
3.2 Display and Initial Settings at Power-on	3-5
3.3 I/O Terminals.....	3-7
3.3.1 Output terminals (front and rear)	3-7
3.3.2 USB connector	3-10
3.3.3 External control I/O.....	3-11
3.3.4 External signal input/external sync signal input terminal	3-13
3.4 Main Operation Example.....	3-14
3.4.1 Power on/off.....	3-15
3.4.2 Setting output mode	3-17
3.4.3 Setting output voltage range.....	3-19
3.4.4 Setting waveform	3-21
3.4.5 Setting output voltage	3-22
3.4.6 Setting output frequency.....	3-24
3.4.7 Using limiter functions	3-25
3.4.8 Output on/off.....	3-29
3.4.9 Using measurement functions	3-30
3.5 Output Characteristics.....	3-33
4. ADVANCED OPERATION EXAMPLE.....	4-1
4.1 Use as a DC Power Source	4-2
4.1.1 Connecting output terminal to load during DC output.....	4-2

Contents

4.1.2	Selecting an output mode (AC+DC-INT mode)	4-3
4.1.3	Setting the output voltage range.....	4-5
4.1.4	Setting the output voltage	4-7
4.1.5	Setting output frequency of superimposed AC	4-9
4.1.6	Setting superimposed AC waveform.....	4-10
4.1.7	Use measurement function.....	4-11
4.2	Measurement of Inrush Current	4-14
4.2.1	Inrush current	4-14
4.2.2	Set phase at output on	4-15
4.2.3	Set measurement display to peak value	4-16
4.2.4	Reset the peak current hold value	4-17
4.3	Measurement of Harmonic Current	4-19
4.4	Using the Sequence Function	4-21
4.4.1	Sequence operations	4-21
4.4.2	Sequence settings	4-28
4.4.3	Programming sequences.....	4-30
4.4.4	Control of sequence operations.....	4-36
4.4.5	Clear sequence memory	4-38
4.4.6	Example of sequence operation settings	4-39
4.4.7	Execution of sequence operations	4-43
4.5	Control Using External Control I/O Connector.....	4-47
4.6	Output of Arbitrary Waveforms	4-48
4.7	Synchronization of Output to External Signal.....	4-50
4.7.1	External signal synchronization.....	4-51
4.7.2	Line synchronization	4-53
4.8	Using Memory Functions	4-53
4.9	Amplification of External Signal.....	4-57
4.10	Adding External Signals and Internal Signals.....	4-61
5.	MENUS.....	5-1
5.1	Screen Configuration	5-3
5.1.1	Status icons	5-5
5.1.2	Warnings and error messages	5-6
5.1.3	Sequence display.....	5-6
5.2	Basic Operations	5-7
5.2.1	Menus	5-7
5.2.2	Navigating the menu tree	5-12
5.2.3	Numerical value input operations	5-13
5.2.4	Selection and input operations that require confirmation.....	5-13
5.2.5	EXEC input	5-14
5.2.6	Shortcut keys	5-14
5.3	SET Menu	5-15
5.3.1	Output mode setting	5-16
5.3.2	Output voltage range setting.....	5-17
5.3.3	Setting output voltage	5-18
5.3.4	Setting output frequency.....	5-19

Contents

5.3.5	Output initial phase settings	5-19
5.3.6	Waveform settings	5-19
5.3.7	Output peak current limiter settings	5-20
5.3.8	Output average current limiter settings.....	5-21
5.4	MEASURE Screen	5-22
5.4.1	Output voltage measurement	5-23
5.4.2	Output current measurement	5-24
5.4.3	Output power measurement	5-25
5.4.4	Load power factor measurement	5-25
5.4.5	Load crest factor measurement	5-25
5.4.6	Output harmonic current measurement.....	5-26
5.4.7	External synchronization frequency measurement.....	5-26
5.5	MISC Menu	5-27
5.5.1	Sequence (SEQUENCE)	5-27
5.5.2	Memory (MEMORY)	5-31
5.5.3	Remote (REMOTE)	5-32
5.5.4	System (SYSTEM)	5-32
5.5.5	Setting range limiter (LIMIT).....	5-33
5.5.6	Selection of measurement display (MEASURE)	5-34
5.5.7	Reset of peak current hold value	5-34
5.5.8	Output on/off	5-35
5.6	System Menu	5-36
5.6.1	Keylock.....	5-38
5.6.2	Beep sound	5-39
5.6.3	LCD contrast adjustment.....	5-40
5.6.4	LCD display color setting	5-41
5.6.5	Time unit setting	5-42
5.6.6	Output on/off setting at power-on.....	5-43
5.6.7	External control input enable/disable setting	5-44
5.6.8	Reset function.....	5-45
5.6.9	System information.....	5-45
6.	USB INTERFACE	6-1
6.1	Setup for Use	6-2
6.2	Command List.....	6-3
6.3	Command Descriptions	6-9
6.3.1	Overview of Programming Language.....	6-9
6.3.2	Detailed command descriptions.....	6-14
6.4	Command Tree.....	6-42
6.5	Status System.....	6-43
6.5.1	Status byte	6-44
6.5.2	Standard event status	6-45
6.5.3	Operation status	6-47
6.5.4	Warning status	6-48
6.6	Error Message List	6-49
6.7	Programming Precautions	6-50

Contents

7. TROUBLESHOOTING	7-1
7.1 Protection Function.....	7-2
7.2 Error Messages and Responses.....	7-4
7.2.1 Error at power-on.....	7-5
7.2.2 Protection function-related errors	7-6
7.2.3 Panel operation errors.....	7-8
7.2.4 Warning messages.....	7-10
7.2.5 USB-related external control errors.....	7-13
7.3 When Fault Is Suspected	7-13
8. MAINTENANCE	8-1
8.1 Introduction	8-2
8.2 Routine Maintenance	8-2
8.3 Storage, Repackaging, and Transport	8-4
8.4 Checking the Version Number.....	8-5
8.5 Backup Battery	8-7
9. SPECIFICATIONS	9-1
9.1 Output	9-2
9.2 Current Limiter	9-6
9.3 Setting Range Limits.....	9-6
9.4 Signal Sources	9-7
9.5 Measurement Functions	9-8
9.6 Sequence Function	9-10
9.7 Arbitrary Waveform Memory	9-11
9.8 Setting Memory	9-11
9.9 Protection Functions.....	9-11
9.10 General.....	9-12
9.11 External Control I/O.....	9-13
9.12 USB Interface.....	9-13
9.13 Power Input.....	9-13
9.14 Withstand Voltage and Insulation Resistance	9-14
9.15 Safety and EMC Compliance	9-14
9.16 Ambient Temperature Range, Ambient Humidity Range, Etc.....	9-14
9.17 External Dimensions and Weight	9-15
9.18 EC Declaration of Conformity.....	9-17

Figures

		Page
Figure 1-1.	Block Diagram.....	1-6
Figure 2-1.	Ambient Temperature and Humidity Ranges.....	2-4
Figure 2-2.	Power Source Inlet	2-7
Figure 2-3.	Operation Check.....	2-9
Figure 3-1.	APS-1102 Operation Panel	3-2
Figure 3-2.	APS-1102 Front Panel.....	3-3
Figure 3-3.	APS-1102 Rear Panel	3-4
Figure 3-4.	Output Outlets (Front)	3-7
Figure 3-5.	Output Terminals (Rear)	3-8
Figure 3-6.	Connection to Output Terminals.....	3-9
Figure 3-7.	USB Connector	3-10
Figure 3-8.	External Control I/O Connector.....	3-11
Figure 3-9.	EXT SIG IN/EXT SYNC IN Terminal.....	3-13
Figure 3-10.	POWER Switch.....	3-15
Figure 3-11.	Example of Main Operations Screen (in AC-INT Mode)	3-16
Figure 3-12.	Example of Measured Value Window (AC-INT Mode).....	3-30
Figure 3-13.	Output Voltage vs. Output Current Characteristics (100 V AC Input, AC-INT).....	3-33
Figure 3-14.	Output Voltage vs. Output Current Characteristics (200 V AC Input, AC-INT).....	3-33
Figure 3-15.	Output Voltage vs. Output Current Characteristics (100 V AC Input, AC+DC-INT, AC=0).....	3-34
Figure 3-16.	Output Voltage vs. Output Current Characteristics (200 V AC Input, AC+DC-INT, AC=0).....	3-34
Figure 4-1.	Connection of Block Diode	4-3
Figure 4-2.	Connection of Backflow Diode.....	4-3
Figure 4-3.	Example of Measured Value Window (During AC+DC Mode).....	4-11
Figure 4-2.	Example of Harmonic Measurement Window Display.....	4-20
Figure 4-3.	Example of Basic Step Transitions	4-24
Figure 4-4.	Block Diagram of Sequence Mode Transitions	4-24
Figure 4-5.	Example of Sequence Operation from Hold Mode to <Start>	4-25
Figure 4-6.	Example of Sequence Operation at <Branch>.....	4-25
Figure 4-7.	Loop Specification Method and Step Transition Example	4-26
Figure 4-8.	Example of Step Synchronized Output.....	4-27
Figure 4-9.	Sequence Operation during Wait for Phase 0°	4-27
Figure 4-10.	Sequence Shortcut Keys	4-37
Figure 4-11.	Step Transition Example (during AC+DC-INT mode).....	4-39
Figure 4-12.	LCD Screen During Sequence Execution	4-46
Figure 4-13.	Synchronized TTL Signal	4-50
Figure 4-14.	Example of Settings from Memory.....	4-54

Figures

Figure 5-1.	LCD Screen (When Normal).....	5-3
Figure 5-2.	LCD Screen (When Warning Is Displayed)	5-3
Figure 5-3.	Menu Tree.....	5-7
Figure 5-4.	Modification Box.....	5-13
Figure 5-5.	Selection Box.....	5-13
Figure 5-6.	EXEC Box.....	5-14
Figure 5-7.	Block Diagram of Signal Sources	5-17
Figure 6-1.	Binary Block Data	6-10
Figure 6-2.	Partial Command Tree	6-11
Figure 6-3.	Command Tree	6-42
Figure 6-4.	Status System	6-43
Figure 6-5.	Standard Event Status Register	6-45
Figure 6-6.	Operation Status	6-47
Figure 6-7.	Warning Status.....	6-48
Figure 7-1.	Screen Display When Self Fault Check Errors Have Occurred	7-5
Figure 7-2.	Screen Display When Protection Function-Related Error Has Occurred.....	7-6
Figure 7-3.	Screen Display When Panel Operation Error Has Occurred.....	7-8
Figure 7-4.	Screen Display When Warning Has Occurred	7-11
Figure 8-1.	Air Filter Cleaning Steps	8-3
Figure 8-2.	SYSTEM INFORMATION Screen	8-6
Figure 9-1.	Temperature and Humidity Ranges.....	9-15
Figure 9-2.	External Dimensions	9-16

Tables

		Page
Table 1-1.	List of Functions (1/2)	1-4
Table 1-2.	List of Functions (2/2)	1-5
Table 2-1.	Panel Settings for Operation Check	2-9
Table 3-1.	Settings in Memory (1/2)	3-5
Table 3-2.	Settings in Memory (2/2)	3-6
Table 3-3.	External Control I/O Connectors.....	3-12
Table 3-4.	Output Mode List	3-17
Table 3-5.	List of Setting Ranges for Various Output Voltage Range.....	3-19
Table 3-6.	AC Voltage Waveform and AC Current Waveform List.....	3-21
Table 3-7.	Output Voltage Settings	3-22
Table 3-8.	Output Frequency Setting	3-24
Table 3-9.	Current Limiter Setting Ranges	3-25
Table 3-10.	Voltage and Frequency Setting Range Limiter	3-27
Table 4-1.	Panel Settings When Using APS-1102 as a DC Power Source	4-2
Table 4-2.	Setting Range Options for Various Output Voltage Ranges	4-5
Table 4-3.	Output Voltage Setting Ranges When AC+DC Mode Is Selected.....	4-7
Table 4-4.	Step Execution Parameters	4-22
Table 4-5.	Step Transition Parameters.....	4-23
Table 4-6.	Sequence Modes.....	4-24
Table 4-7.	Sequence Control	4-25
Table 4-8.	Setting Items in PROGRAM Screen (1/3)	4-31
Table 4-9.	Setting Items in PROGRAM Screen (2/3)	4-32
Table 4-10.	Setting Items in PROGRAM Screen (3/3)	4-33
Table 4-11.	Items in CONTROL Selection Box.....	4-36
Table 4-12.	Program Settings.....	4-39
Table 4-13.	Functions of External Control I/O Connector.....	4-47
Table 4-14.	Menu Items in MEMORY Screen	4-54
Table 4-15.	External Input Gain Setting Range	4-57
Table 5-1.	Status Icons List.....	5-5
Table 5-2.	Sequence Display	5-6
Table 5-3.	Items in SET Menu	5-8
Table 5-4.	Items in MISC Menu	5-9
Table 5-5.	Items in SEQUENCE Menu	5-10
Table 5-6.	Items in MEMORY Menu	5-10
Table 5-7.	Items in REMOTE Menu	5-11
Table 5-8.	Items in SYSTEM Menu.....	5-11
Table 5-9.	Items in LIMIT Menu.....	5-11
Table 5-10.	Shortcut Keys	5-14

Tables

Table 5-11.	SET Menu Items and Output Modes	5-15
Table 5-12.	Output Modes	5-16
Table 5-13.	Output Voltage Settings	5-18
Table 5-14.	Output Frequency Setting	5-19
Table 5-15.	Output Initial Phase Settings	5-19
Table 5-16.	Output Peak Current Limiter Setting Range	5-20
Table 5-17.	Output Average Current Limiter Setting Range	5-21
Table 5-18.	Display Items in MEASURE Screen	5-22
Table 5-19.	Items in CONTROL Selection Box	5-27
Table 5-20.	PROGRAM Screen Items (1/3)	5-28
Table 5-21.	PROGRAM Screen Items (2/3)	5-29
Table 5-22.	PROGRAM Screen Items (3/3)	5-30
Table 5-23.	Setting Range Limit (LIMIT)	5-33
Table 6-1.	Command List (SOURce Subsystem)	6-3
Table 6-2.	Command List (MEASure Subsystem)	6-4
Table 6-3.	Command List (DISPlay Subsystem)	6-4
Table 6-4.	Command List (STATus Subsystem)	6-5
Table 6-5.	Command List (OUTPut Subsystem)	6-5
Table 6-6.	Command List (INPut Subsystem)	6-5
Table 6-7.	Command List (TRACe Subsystem)	6-5
Table 6-8.	Command List (SYSTem Subsystem)	6-6
Table 6-9.	Command List (PROGram Subsystem)	6-6
Table 6-10.	Common Command List (Common Commands and Queries)	6-7
Table 6-11.	Numerical Value Data Format	6-10
Table 6-12.	Character Data Format	6-10
Table 6-13.	Status Byte Register Definitions	6-44
Table 6-14.	Standard Event Status Register Definitions	6-46
Table 6-15.	USB Error Message List	6-49
Table 7-1.	Protection Function	7-3
Table 7-2.	Self Fault Check Messages	7-5
Table 7-3.	Protection Function-Related Errors	7-7
Table 7-4.	Panel Operation Errors (1/2)	7-8
Table 7-5.	Panel Operation Errors (2/2)	7-9
Table 7-6.	Warning Messages (1/2)	7-11
Table 7-7.	Warning Messages (2/2)	7-12
Table 7-8.	USB Error Message List	7-13
Table 7-9.	When Fault Is Suspected (Problem when Switching Power on/off)	7-14
Table 7-10.	When Fault Is Suspected (Problem During Key Operation)	7-14
Table 7-11.	When Fault Is Suspected (Problem Related to Output Voltage or Output Voltage Range Setting)	7-15
Table 7-12.	When Fault Is Suspected (Problem Related to Frequency Setting)	7-15
Table 7-13.	When Fault Is Suspected (Problem Related to Output Error)	7-16

Tables

Table 7-14.	When Fault Is Suspected (Problem Related to Measurement Functions).....	7-17
Table 7-15.	When Fault Is Suspected (Problem Related to Sequence Function).....	7-17
Table 7-16.	When Fault Is Suspected (Problem Related to Memory Function).....	7-17
Table 7-17.	When Fault Is Suspected (Problem Related to Limiter Setting Range Limit)	7-18
Table 7-18.	When Fault Is Suspected (Other Problems)	7-18

1. VERVIEW

1.1	General	1-2
1.2	Features	1-2
1.3	Applications	1-3
1.4	List of Functions	1-4
1.5	Operation Principles	1-6

1.1 General

The APS-1102 programmable AC/DC power source is a power source that can output AC and DC power, features a compact design for convenient desktop use, and provides a wealth of measurement functions. Rated output voltage is 100 Vrms (100 V range) or 200 Vrms (200 V range), with maximum output capacity of 1 kVA (during AC 200 V input).

It also features eight output modes, with DC output, external input amplification, and line-synchronized output.

The APS-1102 can be controlled remotely from an external computer via a USB interface. The accompanying software supports use of the following functions.

- Panel operations
- Sequence editing and execution
- Arbitrary waveform editing and transfer
- Data logger (by capturing measured values)

Worldwide power supply input is supported. Input power factor control function minimizes power supply input current.

1.2 Features

- **Control panel with large LCD screen**

Settings and measured values are displayed on a large, easy-to-read backlit screen.

- **Various output modes**

Output modes include two operation modes: alternate current (AC) and direct current (AC+DC), each of which can be combined with four signal source modes: internal (INT), external (EXT), internal + external (ADD), and external synchronization (SYNC) for a total of eight modes. In the AC mode, DC component is removed.

- **Various measurement functions**

The APS-1102 is equipped with the following measurement functions.

- Voltage (RMS value, average DC value, peak value)
- Current (RMS value, average DC value, peak value, peak hold)
- Power (effective, reactive, apparent)
- Frequency (only in the external synchronization mode)
- Load power factor
- Load crest factor
- Harmonic current (up to 40th harmonic, 50/60 Hz fundamental only)

- **Enables AC-superimposed DC output**

When in the AC+DC mode, an AC wave (sine wave, square wave, or arbitrary waveform) can be superimposed on the DC output.

- **Also supports capacitor input load (up to crest factor 4 is supported)**

Enables peak current output of up to four times as large as the rated current (RMS value).

- **Can be used as an external input amplifier**

When “internal + external” is selected, an internal signal source can be added to the external signal input.

- **Sequence function**

When using an internal signal source, output parameters (output voltage, output frequency, etc.) can be successively and rapidly changed or swept. In addition, output of specified patterns can be provided by program in advance.

- **Output current limiter function, voltage and frequency upper limit and lower limit setting functions**

The output current is limited within the maximum values that have been set independently for positive and negative. As for the output voltage and the output frequency, their setting ranges can be adjustable.

- **USB interface (USBTMC) is standard equipped**

A USB interface is provided for external control, such as from a personal computer.

- **Output outlets equipped on front panel (universal type)**

Various types of power plugs from around the world can be connected.

- **Supports worldwide range input power line voltages**

Input power factor control (PFC) function for 90 V AC to 250 V AC helps minimize input power line current.

1.3 Applications

- **Research, development, and testing of various small-capacity built-in power source units**

- **Research, development, and testing of various compact consumer electronics devices**

- **Testing of battery-powered modules**

- **As power source for testing characteristics of relays and switches**

- **As power source for tests included in inspection lines for various devices**

1.4 List of Functions

The main functions of the APS-1102 are listed below.

Table 1-1. List of Functions (1/2)

	Function	Description
Output system	Output mode	Total of 8 modes (combinations of operation mode and signal source mode) Alternate current – internal signal source (AC-INT mode) Alternate current – external signal source (AC-EXT mode) Alternate current – internal + external signal sources (AC-ADD mode) Alternate current – external synchronization (AC-SYNC mode) Direct current – internal signal source (AC+DC-INT mode) Direct current – external signal source (AC+DC-EXT mode) Direct current – internal + external signal sources (AC+DC-INT mode) Direct current – external synchronization (AC+DC-SYNC mode)
	Output on/off switch	
	Output voltage range	100 V range and 200 V range
	Output voltage waveform (not including external signal source mode)	Sine wave, square wave, arbitrary waveform (16 types)
	Output current limiter	Output peak current limiter function and output average current limiter function (variable limit values)
	Setting range limiter (not including external signal source mode)	Setting range limiter function for output voltage and output frequency Internal mode (AC-INT, AC+DC-INT) and internal + external mode (AC-ADD, AC+DC-ADD) only Setting range limiter function for output voltage External synchronization mode (AC-SYNC, AC+DC-SYNC)
	Sequential output	Output parameters: jump or sweep.
	Synchronized output	Can be synchronized with external sync signal or line frequency
Measurement function	Basic measurements	Voltage: RMS, average, peak Current: RMS, average, peak, peak hold Power: Effective, reactive, apparent
	Other	Synchronization frequency: Only in SYNC mode Load power factor Load crest factor Harmonic current: 50/60 Hz fundamental only, up to 40th

Table 1-2. List of Functions (2/2)

	Function	Description
External control	External control I/O	<p>External control operation modes: Enable, disable</p> <p>Control input:</p> <ul style="list-style-type: none"> Input level: High level: +4.0 V or higher Low level: +1.0 V or lower Non-destructive max. input: +10 V/-5 V Input impedance: Pulled up to +5 V with 47 kΩ <p>Control items: Output on/off, sequence start/stop, hold, branch</p> <p>Status output:</p> <ul style="list-style-type: none"> Output level: 0/+5 V (open) Output impedance: 100 Ω Status items: Power on/off, output on/off, limiter operation, software busy, sequence operation step sync output <p>Terminal: D-sub 25-pin multiterminal</p>
	USB interface	Standard equipped

1.5 Operation Principles

Figure 1-1 shows a block diagram of the APS-1102.

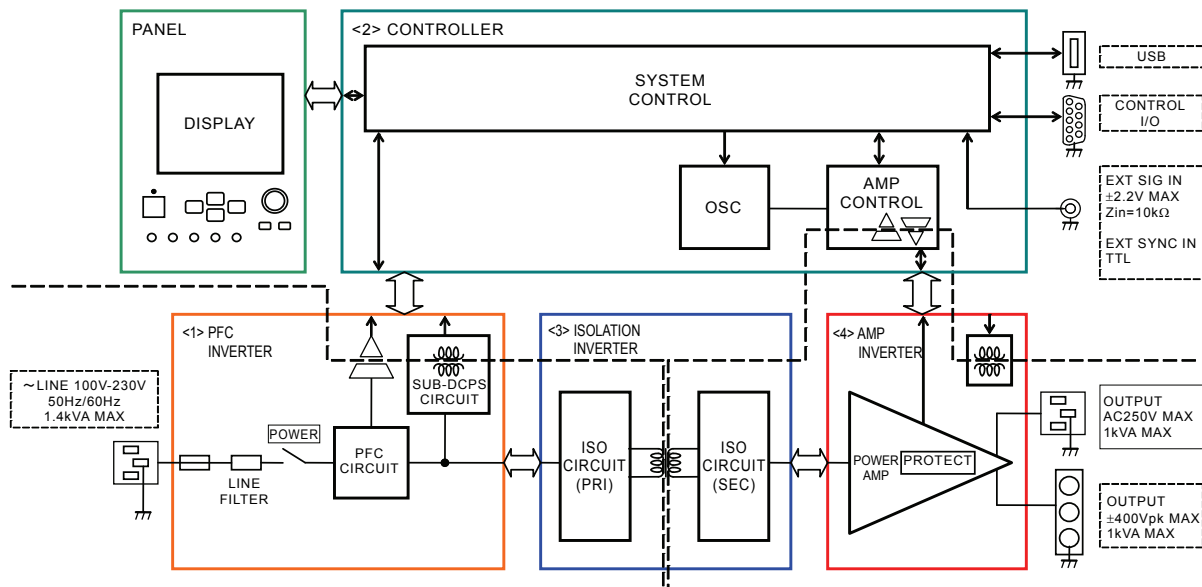

Figure 1-1. Block Diagram

The APS-1102 is broadly divided into four blocks.

<1> DC power source block

The DC power source block includes power factor improvement functions. The block provides DC power sources for various devices on PCBs and for the amplifier block, while improving the power factor of power supply input.

<2> Signal source and system control block

This block includes an internal signal source with sequence functions, and is able to provide AC+DC output. It can also be used with added external inputs and internal signal sources. This block also contains the user interface.

<3> Isolation block

The isolation block isolates the primary (main power source circuitry) and secondary sides.

<4> Amplifier block

The amplifier block includes a protection circuit.

2. **P** REPARATIONS BEFORE USE

2.1	Checking Before Use	2-2
2.2	Installation Environment	2-3
2.3	Grounding and Power Supply Connection	2-6
2.4	Simple Operation Checks	2-8
2.5	Calibration	2-10

2.1 Checking Before Use

Before installing and using the APS-1102, make sure that it has not been damaged during shipment, and check that all the accessories and all parts of the main unit are included. If anything is missing, contact the Good Will distributor from which the product was purchased.

■ Safety check

To ensure safety in using the APS-1102, the user should read the following sections of this user manual before using the APS-1102:

- **“Safety Precautions”** (provided at the beginning of this user manual)
- **“2.3 Grounding and Power Supply Connection”**

■ Appearance and accessories check

If an abnormality (such as a flaw or dent) is found on the outside surface of the corrugated box, carefully check if the product is adversely affected when removing the product from the corrugated box.

After opening the corrugated box, check the items contained in the box.

If an abnormality such as a flaw or dent is found on the product, or an accessory is missing, contact Good Will or its representative.

- Appearance check

Check that no abnormalities such as a flaw and dent are found on the panel, controls, connectors, and so forth.

- Accessories check

The accessories of this product are listed below. Check that there are no missing items and no flaws are found.

● User Manual (APS-1102 User Manual)	1
● Control software (CD-ROM)	1
● Power cord set 1 (varies depending on destination, 15 A/125 V for Japan)	1
● Power cord set 2 (10 A/250 V, without plug, for Japan, North America, and Europe only)	1
● Ferrite core (for USB cord)	1

WARNING

This product contains high-voltage parts. Never remove the cover.

All internal inspections of this product are to be performed only by service technicians qualified by Good Will Company.

2.2 Installation Environment

Note the following precautions to ensure the safe use and reliability of this product.

■ Installation sites

- Do not set the product on its top or side when installing it on a floor or desktop.
- Make sure that the four rubber feet on the bottom of the product are set evenly on a flat surface when placed on a floor or desktop.
- To prevent risk of toppling, be sure to set this product on a surface that is level and is not subject to vibration, so that it can securely support this product weight (approximately 9.5 kg).

■ Cautions for transport

When transporting this product, use the grips on the top side to keep the product upright while moving it horizontally.

CAUTION

If the APS-1102 is exposed to sudden shifts in ambient temperature and/or humidity during transportation in winter, internal condensation may occur.

In such a case, leave the APS-1102 until the condensation has cleared before connecting the APS-1102 to a power supply.

■ **Conditions of installation site**

- The APS-1102 should be used indoors, and at an elevation of 2,000 meters.
- The APS-1102 uses a fan for forced-air cooling. To allow for ample air flow, be sure to maintain a gap of at least 50 cm between the air inlets and outlets along the sides and rear of this product and walls or other obstructions.
- Install this product in a location that meets the following conditions for temperature and humidity ranges.

Operation guarantee	0°C to +40°C	5 to 85%RH Absolute humidity of 1 to 25 g/m ³ , no condensation.
Performance guarantee	+5°C to +35°C	5 to 85%RH Absolute humidity of 1 to 25 g/m ³ , no condensation.
Storage condition	-10°C to +50°C	5 to 95%RH Absolute humidity of 1 to 29 g/m ³ , no condensation.

Product reliability may decline in extreme temperature and/or humidity environments. An environment of approximately 25°C and 50%RH is recommended.

Figure 2-1 illustrates these ambient temperature and humidity ranges.

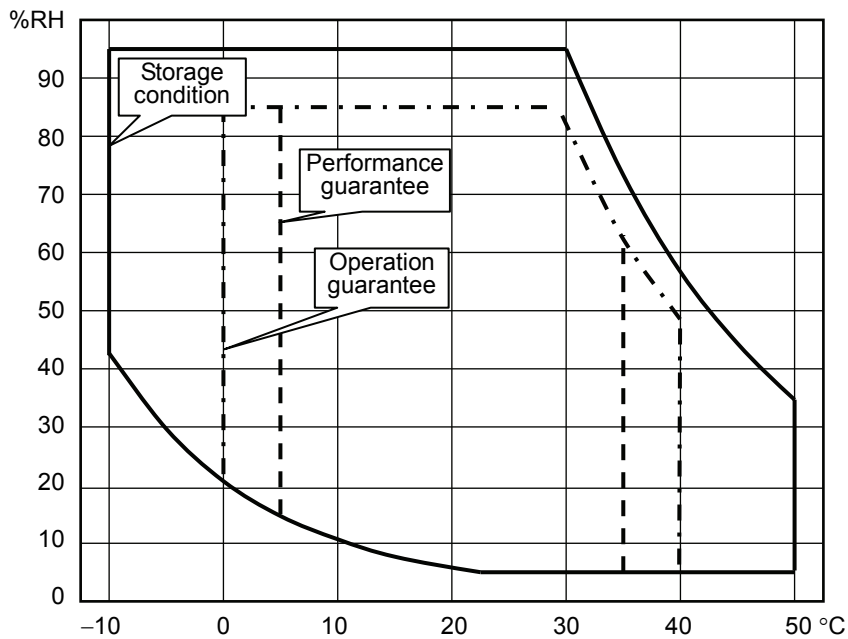

Figure 2-1. Ambient Temperature and Humidity Ranges

- Do not install the APS-1102 in the following locations:
 - Location with flammable gas
 - An explosion may occur. Never install and use this product in such a location.
 - Outdoors, or location exposed to direct sunlight or near a fire or heat source
 - The full performance of this product may not be obtained, or failure may occur.
 - Location with corrosive gas, moisture, or high humidity
 - This product may become corroded or fail.
 - Location near an electromagnetic field source, high-voltage device, or power line
 - This product may malfunction.
 - Location exposed to excessive vibration
 - This product may malfunction or fail.
 - Location with excessive dust
 - In particular, electrically conductive dust may cause failure of this product.

2.3 Grounding and Power Supply Connection

- **Be sure to ground the APS-1102.**

⚠ WARNING

This product uses a line filter. Be sure to ground this product. Otherwise, an electric shock may occur.

To prevent an electric shock from occurring, be sure to ground the APS-1102 according to "Electric Equipment Technical Standard Class D (100 Ω or below) Grounding" or higher.

When the input power line is 100 V AC, use power cord set 1. When a 3-prong power plug that includes a protective ground contact is connected to a 3-prong power supply outlet, this product is grounded automatically. Power cord set 1 (Japan version) is rated at 125 V AC.

When the input power line is 200 V AC, use power cord set 2 equipped with a terminal or crimp contact that suits the type of outlet to be used. Always connect a ground when using power cord set 2. Power cord set 2 is rated at 250 V AC.

A 3-prong/2-prong conversion adapter is not provided with this product. If a 3-prong/2-prong conversion adapter is used, the adaptor ground wire must be connected to a ground contact next to the outlet.

- **The power requirements of this product are as follows:**

Voltage range: 100 V AC to 230 V AC \pm 10 % (when at 250 V or less)
Overvoltage category II

Frequency range: 50 Hz/60 Hz \pm 2 Hz (single phase)

Power consumption: 1.4 kVA or less

■ **Connect the power in this order.**

1. Make sure that the power source voltage to be used is within the specified range.
2. Set the power switch to off.
3. Insert the power cord into the inlet on the rear panel.

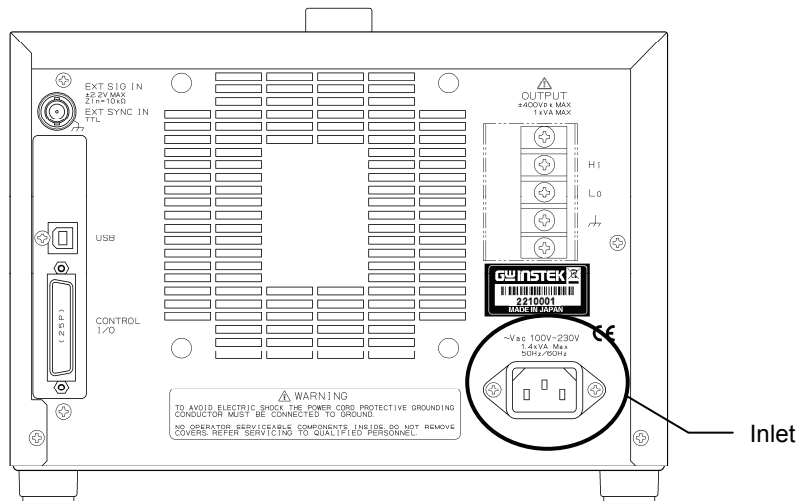

Figure 2-2. Power Source Inlet

4. Insert the power cord plug into a 3-prong power source outlet (use the supplied power source cord set 1).

⚠ CAUTION

The accompanying power cord set 1 (Japan version) complies with Japan Electrical Appliance and Material Safety Law and is for use in Japan only. The rated voltage is 125 V AC and the withstand voltage is 1250 V AC. This power cord set cannot be used when the voltage exceeds 125 V AC or in locations outside of Japan.

⚠ CAUTION

The accompanying power cord set 2 is intended for use in Japan, North America, and Europe. The rated voltage is 250 V AC and the withstand voltage is 2000 V AC. Attach a plug or crimp contact that suits the use environment. When using this cord set in Japan, be sure to use a plug that complies with Japan Electrical Appliance and Material Safety Law.

⚠ CAUTION

The accompanying power cord sets are for use with this product only. Do not use them with other products or application systems.

The product itself has a withstand voltage of 1500 V AC.

2.4 Simple Operation Checks

The following describes simple methods for checking newly purchased products or products that have been in long-term storage.

WARNING

This product contains high-voltage parts. Never remove the cover.
All internal inspections of this product are to be performed only by service technicians qualified by Good Will.

Check that the power goes on normally, and that the measured value set via the control panel is displayed correctly on the MEASURE screen.

■ Operation steps

1. Set the APS-1102 power source switch to on.  See “3.4.1 Power on/off”.

⇒ Operation starts once the power is on.

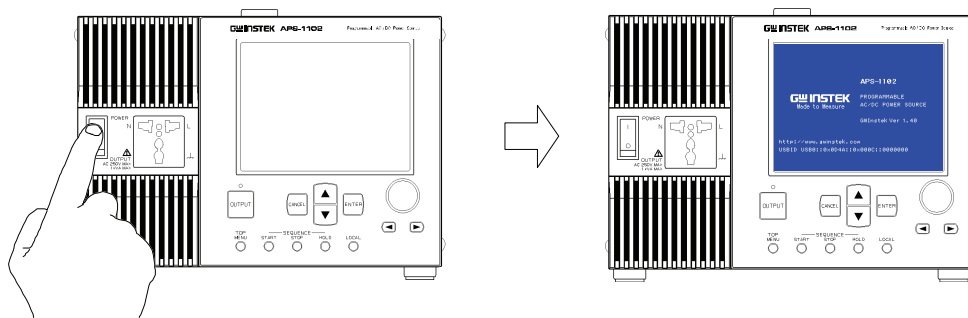

<1> Press switch to up (|) position.

<2> The LCD goes on and displays the initial screen.

The main operations screen that appears immediately after the power-on shows the same settings that were displayed the last time the power was turned off. When a newly purchased unit is turned on for the first time, the initial settings (factory settings) are displayed.

⇒  See “3.2 Display and Initial Settings at Power”, for description of the initial settings.

2. Panel settings

Set the APS-1102 as shown below.  See “3.4 Main Operation Example”, for descriptors of the settings methods.

Table 2-1. Panel Settings for Operation Check

Item	Setting
Output mode	AC-INT mode
Output voltage range	100 V
AC output voltage	100 Vrms
Selected measurement display	RMS



⇒ Check that the control panel MEASURE screen shows 100 Vrms as the AC output voltage.

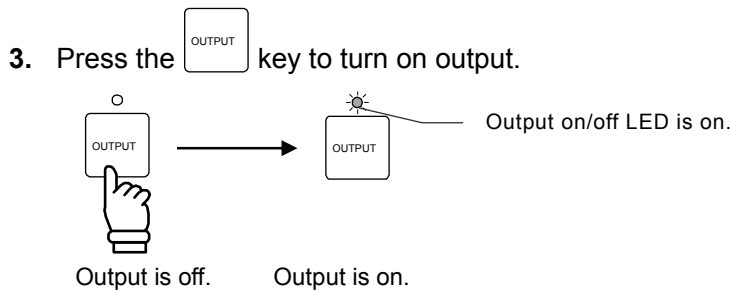
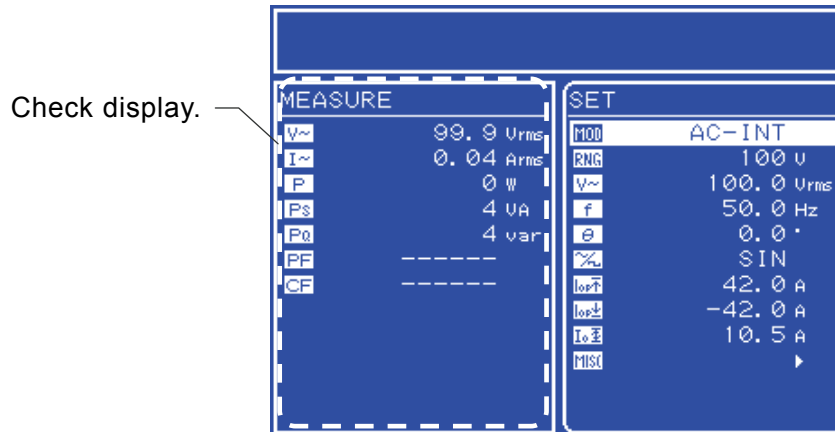

Figure 2-3. Operation Check

⇒ If the normal values are not displayed, it may be due to an operation fault. Contact Good Will or a Good Will representative.

4. Turn off the power, check that OUTPUT off is displayed, then press the power switch to the bottom (O) position. This shuts off the power supply and turns off the power source unit.

⚠ CAUTION

Before turning off the power, make sure that the output on/off LED is off.

2.5 Calibration

To calibrate the APS-1102, contact Good Will or an authorized distributor.

3. **P**ANEL AND BASIC OPERATIONS

3.1	Panel Components and Operations	3-3
3.1.1	Operation panel.....	3-3
3.1.2	Front panel.....	3-4
3.1.3	Rear panel.....	3-5
3.2	Display and Initial Settings at Power-on	3-6
3.3	I/O Terminals	3-8
3.3.1	Output terminals (front and rear)	3-8
3.3.2	USB connector.....	3-11
3.3.3	External control I/O.....	3-12
3.3.4	External signal input/external sync signal input terminal	3-14
3.4	Main Operation Example.....	3-15
3.4.1	Power on/off.....	3-16
3.4.2	Setting output mode.....	3-18
3.4.3	Setting output voltage range	3-20
3.4.4	Setting waveform	3-22
3.4.5	Setting output voltage	3-23
3.4.6	Setting output frequency	3-25
3.4.7	Using limiter functions.....	3-26
3.4.8	Output on/off	3-30
3.4.9	Using measurement functions	3-31
3.5	Output Characteristics	3-34

3.1 Panel Components and Operations

3.1.1 Operation panel

Numbers shown after names in this figure correspond to item numbers in the detailed descriptions below.

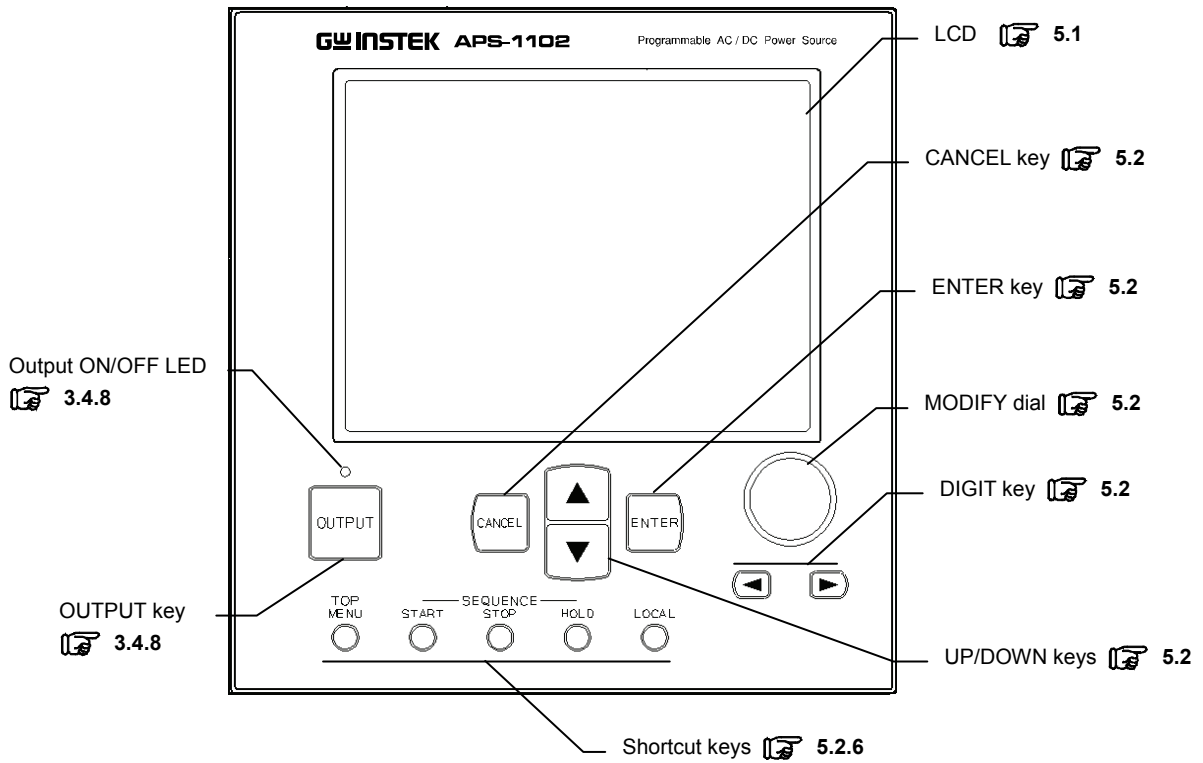

Figure 3-1. APS-1102 Operation Panel

3.1.2 Front panel

Numbers shown after names in the following two figures correspond to item numbers in the detailed descriptions below.

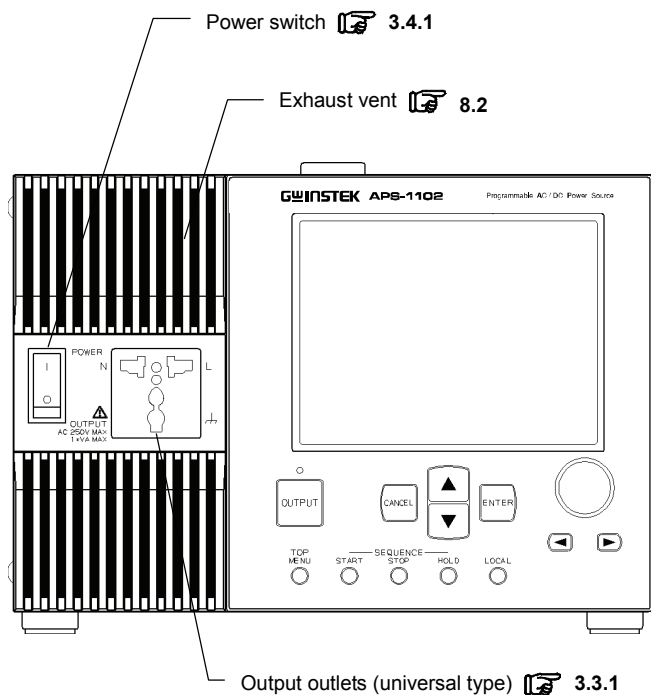

Figure 3-2. APS-1102 Front Panel

3.1.3 Rear panel

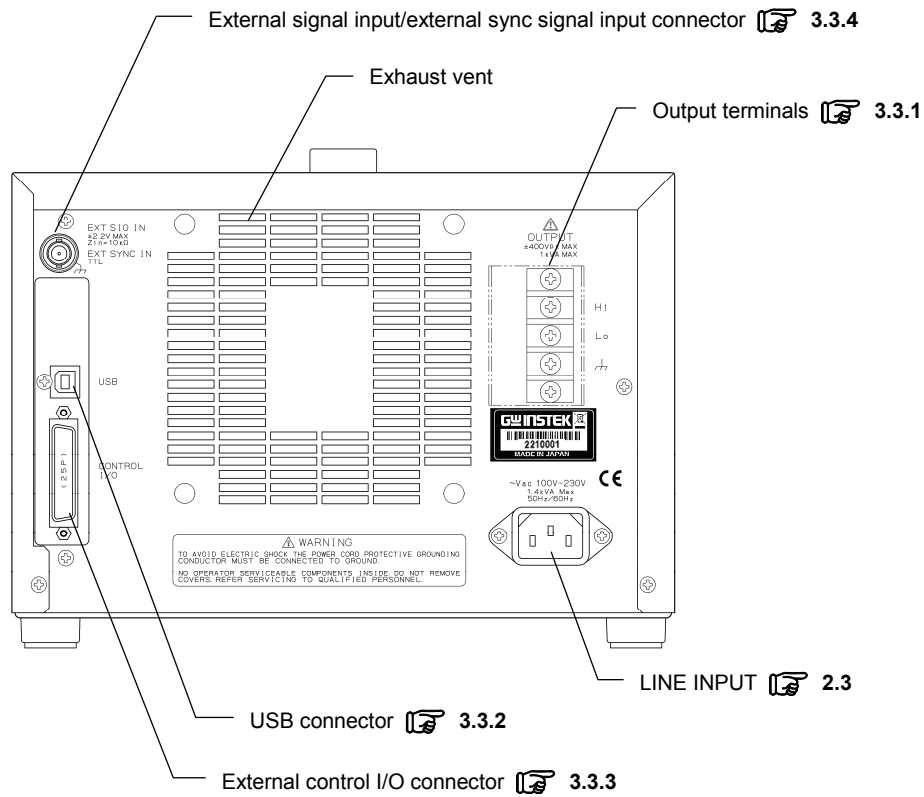



Figure 3-3. APS-1102 Rear Panel

3.2 Display and Initial Settings at Power-on

■ **Display at power-on**

When the power switch is set to on, a fault check is performed automatically, and when that ends normally operation mode is set.

The settings shown on the panel are those that were shown the last time the power source was turned off. When a newly purchased unit is turned on for the first time, the initial settings are displayed.

 See “4.8 Using Memory Functions”, for description of how to read settings saved to memory.

An error message is displayed when an abnormality has occurred. After reading the error message, turn the power source off immediately.

 See “7.2.1 Error at power-on”, for description of error messages and recommended responses.

■ **Initial settings**

Table 3-1 and **Table 3-2** list the initial settings for the APS-1102.

Table 3-1. Settings in Memory (1/2)

Function	Setting		Initial Setting	At Power-on
Select output mode	Output mode		AC-INT	Backup value
Select output voltage range	Output voltage range		100 V	Backup value
Select external sync signal source	External sync signal source		LINE	Backup value
AC mode output (AC-INT, AC-ADD, AC-SYNC)	AC voltage	100 V range	SIN/SQU 0.0 Vrms	Backup value
			ARB1 to ARB16 0.0 Vp-p	
	200 V range	SIN/SQU 0.0 Vrms		
		ARB1 to ARB16 0.0 Vp-p		
	AC voltage frequency		50.0 Hz	
	Phase when output goes on		0.0°	
AC voltage waveform		Sine wave (SIN)		
AC+DC mode output (AC+DC-INT, AC+DC-ADD, AC+DC-SYNC)	DC voltage	100 V range	0.0 V	Backup value
		200 V range	0.0 V	
	AC voltage	100 V range	SIN/SQU 0.0 Vrms	
			ARB1 to ARB16 0.0 Vp-p	
	200 V range	SIN/SQU 0.0 Vrms		
		ARB1 to ARB16 0.0 Vp-p		
	AC voltage frequency		50.0 Hz	
	Phase when output goes on		0.0°	
AC voltage waveform		Sine wave (SIN)		

Table 3-2. Settings in Memory (2/2)

Function	Setting	Initial setting	At Power-on	
Current limiter	Output peak current limiter (positive)	100 V range	+42.0 A	Backup value
		200 V range	+21.0 A	
	Output peak current limiter (negative)	100 V range	-42.0 A	
		200 V range	-21.0 A	
	Output average current limiter	100 V range	10.5 A	
200 V range		5.3 A		
Setting range limit	Positive voltage setting limit	100 V range	+200.0 V	Backup value
		200 V range	+400.0 V	
	Negative voltage setting limit	100 V range	-200.0 V	
		200 V range	-400.0 V	
	Frequency upper limit setting limit		550.0 Hz	
Frequency lower limit setting limit		1.0 Hz		
External input gain setting	External input gain	100 V range	100	Backup value
		200 V range	200	
Select measurement display	Measurement display	RMS	Backup value	
Sequence output	Step time		0.1000 s	Backup value
	Step operation type		Constant (CONST)	
	Step end phase enable/disable		Disable (DISABLE)	
	Step end phase		0.0°	
	Step termination		End (STOP)	
	Jump steps		0	
	Jump court		1	
Branch steps		0		
System settings	Keylock		OFF	Backup value
	Beep		ON	Backup value
	LCD contrast		55	Backup value
	LCD display color		Blue (BLUE)	
	Time unit		s	Backup value
	Output on/off at power-on		OFF	Backup value
External control input enable/disable		Disable	Backup value	

3.3 I/O Terminals

3.3.1 Output terminals (front and rear)

■ Connection to output outlet (front)

The front panel is equipped with universal type output outlets that accommodate power plug types from various countries. These outputs are isolated from the power inputs and case (ground connection). These outlets are used only for AC power. Use the rear output terminal for DC or AC+DC.

Polarity follows the Japanese standard. Use the rear output terminal for polarity-related settings such as the initial phase.

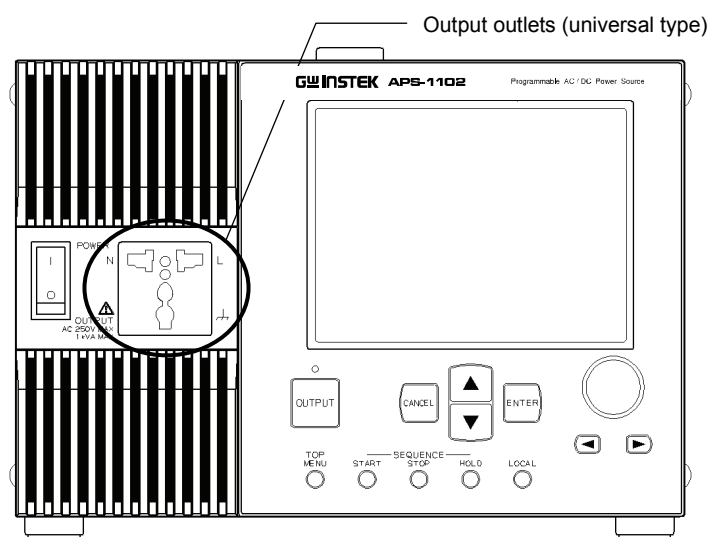

Figure 3-4. Output Outlets (Front)

■ **Connection to output terminals (rear)**

Outputs are isolated from the input power lines and the case (ground connection). When connecting to an output terminal, attach a round crimp contact with a sleeve that has sufficient capacity for the output current.

DC output is based on “Lo”, so that the + polarity setting sets “Hi = positive”, and the - polarity setting sets “Hi = negative”.

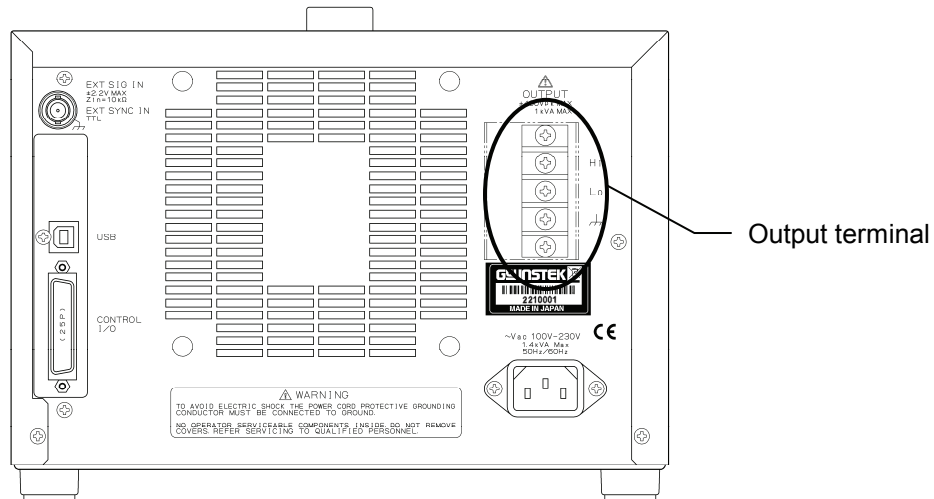

Figure 3-5. Output Terminals (Rear)

⚠ WARNING

When output is on, do not touch the output terminal block.
To ensure safety, always attach the supplied terminal cover.

■ **Connect cables to the output terminal block as described below.**

Outputs are isolated from the input power lines and case.

1. Remove a screw attached to the output terminal block.
2. Insert the screw through the round crimp contact at the end of the cable.
3. Reattach the screw into the OUTPUT terminal while holding the crimp contact in place.
4. Turn the screw until it is securely fastened. The recommended fastening torque is 1.2 (N·m).
5. Connect the Hi, Lo, and ground cables, then attach the terminal cover.

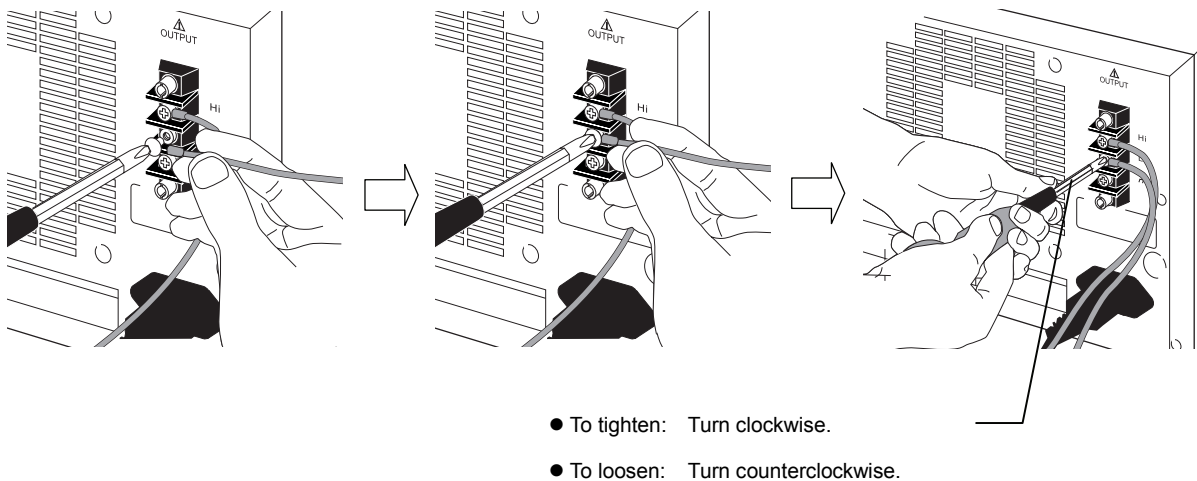

Figure 3-6. Connection to Output Terminals

⚠ WARNING

To ensure safety, always turn the power off before connecting to output cables.

⚠ CAUTION

When using the APS-1102 as a DC power supply, it is necessary to connect a diode for protection, depending on the load, such as a capacitor and inductor.

For how to connect a diode for protection, refer to “**4.1.1 Connecting output terminal to load during DC output**”.

3.3.2 USB connector

Use a commercial (off-the-shelf) USB cable to connect the rear USB connector to a PC.

Attach the accompanying ferrite core to the USB cable to reduce the leakage electric wave.

☞ See “6. USB INTERFACE”, for description of using a USB connection for remote control from a PC.

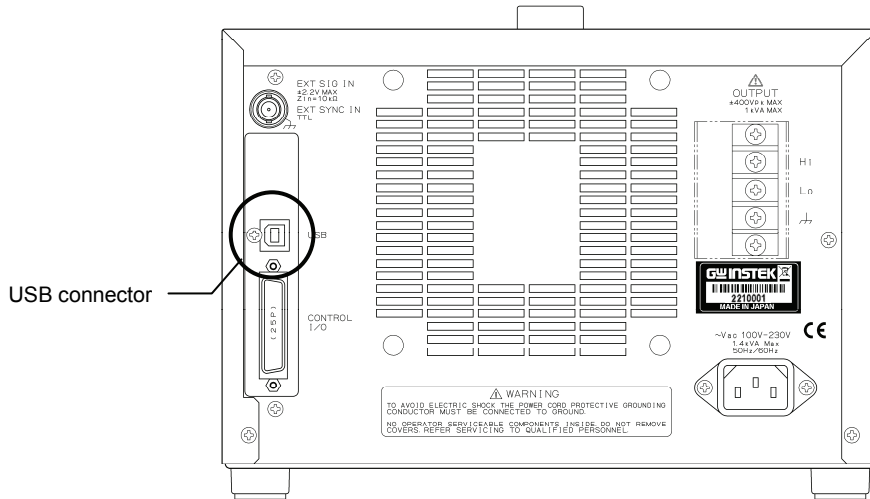

Figure 3-7. USB Connector

⚠ CAUTION

The USB cable should be a commercial Type A (male) to Type B (male) cable.

Attach the accompanying ferrite core to the USB cable to reduce the leakage electric wave.

3.3.3 External control I/O

The APS-1102 is equipped with an (8-bit) external control I/O connector to enable external control using digital signal input and status output using digital signals. The connector is a D-sub 25-pin type.

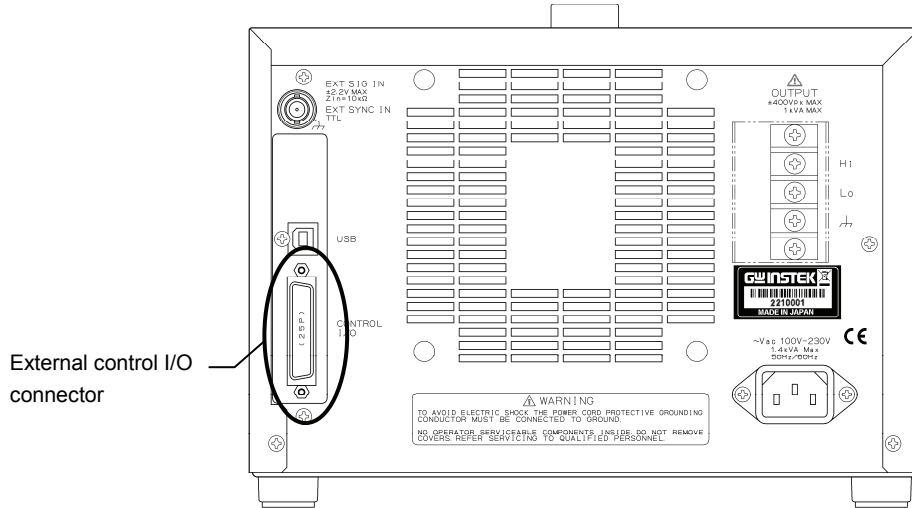

Figure 3-8. External Control I/O Connector

The signals corresponding to the pins in this connector are listed below in “**Table 3-3 External Control I/O Connectors**”.

Table 3-3. External Control I/O Connectors

Pin No.	I/O	Function	Remark
1	Output	Power source on/off status	0: Off 1: On
2	Output	Output on/off status	0: Off 1: On
3	Output	Limiter operation ^{Note}	0: Off 1: On
4	Output	Software busy	0: Normal 1: Busy
5	Output	Sequence sync output 0	
6	Output	Sequence sync output 1	
7	Output	Undefined	
8	Output	Undefined	
9	GND	–	
10	Input	Undefined	
11	Input	Output off	Falling edge detection
12	Input	Output on	Falling edge detection
13	Input	Sequence start	Falling edge detection
14	Input	Sequence stop	Falling edge detection
15	Input	Sequence hold	Falling edge detection
16	Input	Sequence branch trigger 0	Falling edge detection
17	Input	Sequence branch trigger 1	Falling edge detection
18	GND	–	
19	Output	+5 V	50 mA or less
20	Output	Reserved	
21	Output	Reserved	
22	Output	Reserved	
23	Output	Reserved	
24	Output	Reserved	
25	Output	Reserved	

Note When output peak current limiter (positive), output peak current limiter (negative), output average current limiter, or output power limiter is operated, it is recognized as limiter operation on.

External control input and output can be used when external control has been set as enabled.

 See “5.6.7 External control input enable/disable setting”.

3.3.4 External signal input/external sync signal input terminal

When using an externally input signal as the signal source with external synchronization, connect to the external signal input/external sync signal input terminals (EXT SIG IN/EXT SYNC IN) on the rear panel. For this connection, use a coaxial cable with a BNC connector.

The specifications for these external signal input/external sync signal input terminals are listed below.

■ **Common specifications**

- Input terminal: BNC-R (used for external signal input and external sync signal input)
- Input impedance: 10 k Ω
- Non-destructive maximum input voltage: ± 10 V

■ **External signal input**

- Frequency range: DC to 500 Hz
- Gain setting range:
 - 100 V range: 0.0 to 200.0 times (initial value is 100.0)
 - 200 V range: 0.0 to 400.0 times (initial value is 200.0)
- Gain setting resolution: 0.1
- Gain accuracy: $\pm 5\%$ (50 Hz, when gain is at initial value with rated voltage output)
- Phase between input and output: In-phase
- Input voltage range: -2.2 V to $+2.2$ V

■ **External synchronization**

- Synchronization frequency range: 40 Hz to 500 Hz
 - * External sync signal is not required when line synchronization is selected.
- Input voltage threshold value: TTL

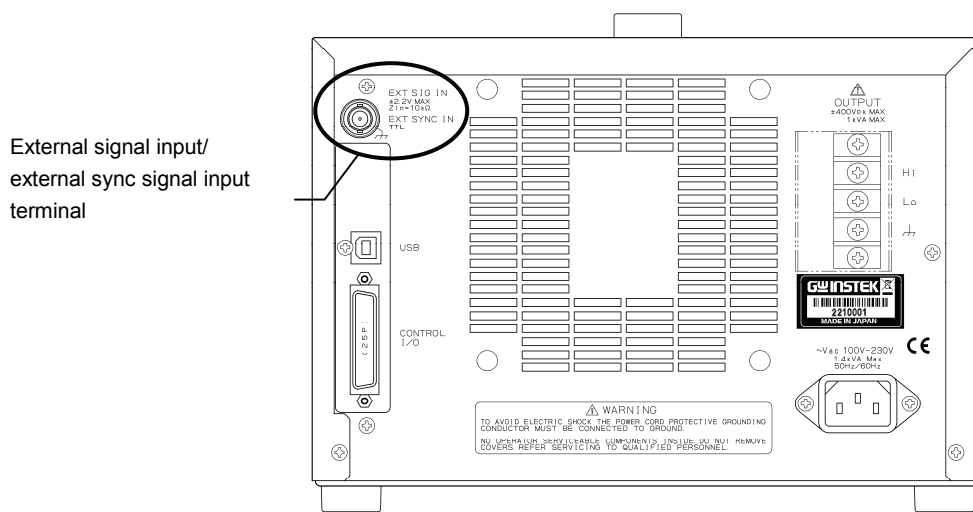

Figure 3-9. EXT SIG IN/EXT SYNC IN Terminal

3.4 Main Operation Example

Main operations are described below in the following order.

■ Power-on	☞ 3.4.1 Power on/off
↓	
■ Set output mode	☞ 3.4.2 Setting output mode
↓	
■ Set output voltage range	☞ 3.4.3 Setting output voltage range
↓	
■ Set waveform	☞ 3.4.4 Setting waveform
↓	
■ Set output voltage	☞ 3.4.5 Setting output voltage
↓	
■ Set output frequency	☞ 3.4.6 Setting output frequency
↓	
■ Use current limiter and setting range limiter	☞ 3.4.7 Using limiter functions
↓	
■ Output on	☞ 3.4.8 Output on/off
↓	
■ Check measured value	☞ 3.4.9 Using measurement functions
↓	
■ Output off	☞ 3.4.8 Output on/off
↓	
■ Power-off	☞ 3.4.1 Power on/off

3.4.1 Power on/off

When the POWER switch is set to “I”, the power goes on, and when it is set to “O”, the power goes off.

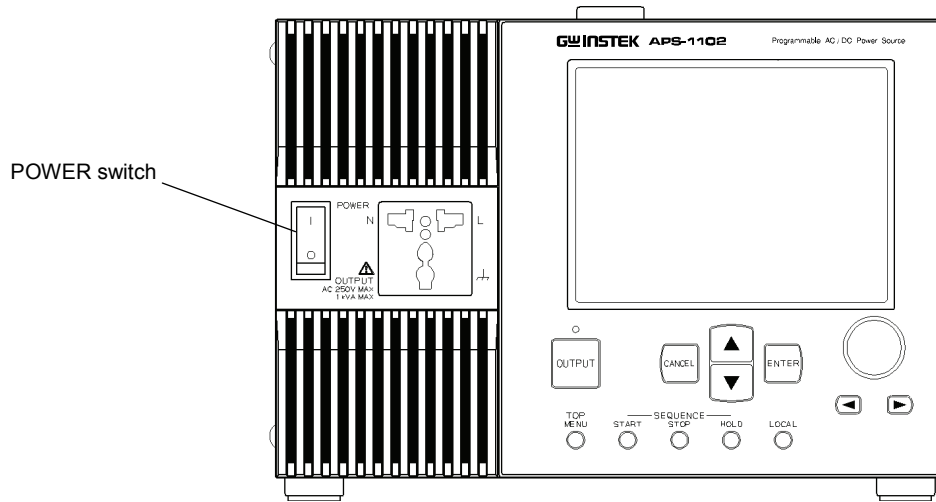
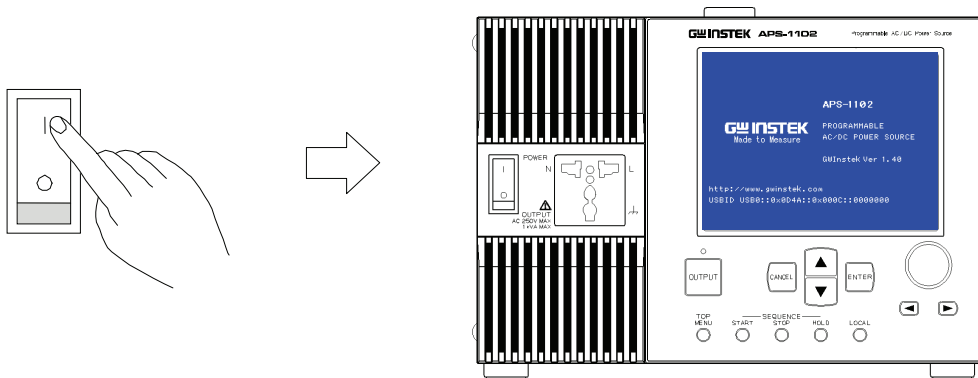

Figure 3-10. POWER Switch

a) Power-on

Set the POWER switch to “I”.



Startup screen is displayed.

⇒ Main operations screen is displayed.

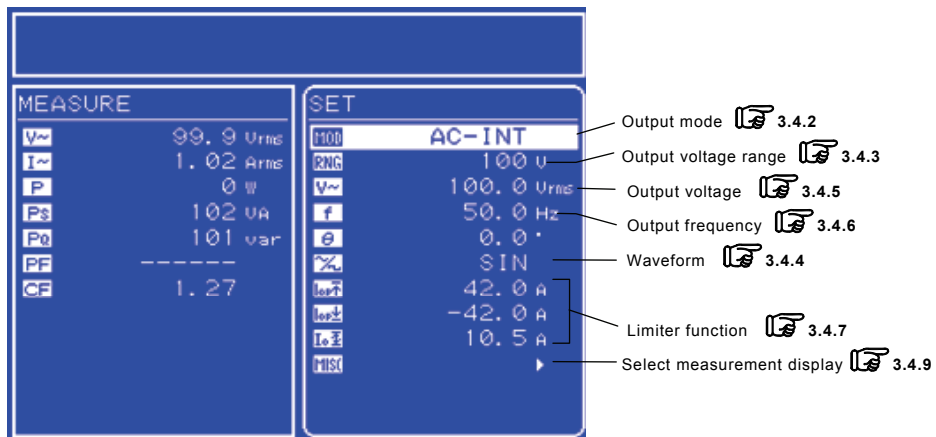

Figure 3-11. Example of Main Operations Screen (in AC-INT Mode)

The main operations screen that appears immediately after the power-on shows the same settings that were displayed the last time the power was turned off. When a newly purchased unit is turned on for the first time, the initial settings (factory settings) are displayed.

- ⇒ See “3.2 Display and Initial Settings at Power-on”, for description of the initial settings.
- ⇒ See “4.8 Using Memory Functions”, for description of how to read settings saved to memory.
- ⇒ See “7. TROUBLESHOOTING”, for a list of warnings and error messages, along with recommended responses.

b) Power-off

After confirming that the output is off, set the POWER switch to “O”.

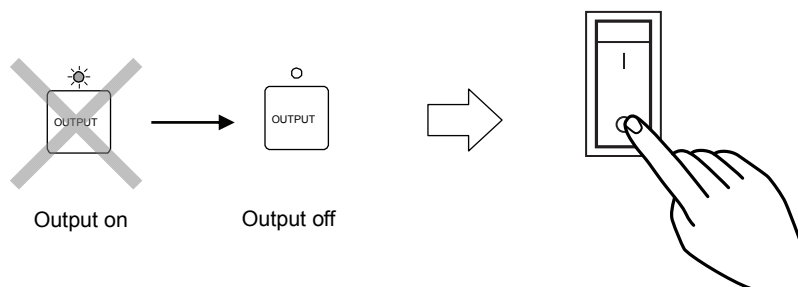

⇒ The power source is cut and turned off.

⚠ CAUTION

- Before turning off the power, make sure the OUTPUT setting is off.

3.4.2 Setting output mode

The APS-1102 provides the eight output modes listed in **Table 3-4**. The output mode cannot be changed while output is on. Before changing the output mode, set output to off.



Table 3-4. Output Mode List

Operation Mode	Signal Source Mode	Output Mode	Reference
AC	INT (internal)	AC-INT	☞ “3.4.2 Setting output mode”
	EXT (external)	AC-EXT	☞ “4.5 Control Using External Control I/O Connector”
	ADD (internal + external)	AC-ADD	☞ “4.10 Adding External Signals and Internal Signals
	SYNC (external sync)	AC-SYNC	☞ “4.7 Synchronization of Output to External Signal”
AC+DC	INT (internal)	AC+DC-INT	☞ “4.1 Use as a DC Power Source”
	EXT (external)	AC+DC-EXT	☞ “4.5 Control Using External Control I/O Connector”
	ADD (internal + external)	AC+DC-ADD	☞ “4.10 Adding External Signals and Internal Signals
	SYNC (external sync)	AC+DC-SYNC	☞ “4.7 Synchronization of Output to External Signal”

Setting to AC-INT mode is described below as an example.

■ **Operation steps**

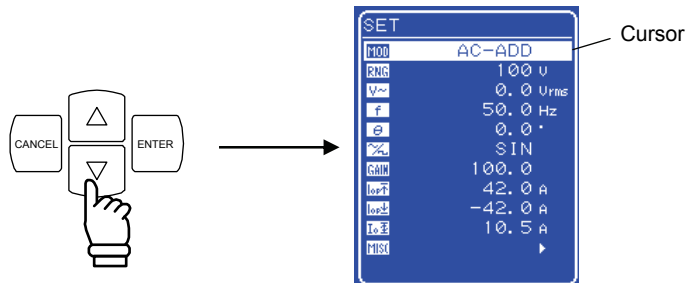

Select output mode by selecting **MOD** in the SET menu.

1. Press the  or  key to move the cursor to the **MOD** icon.

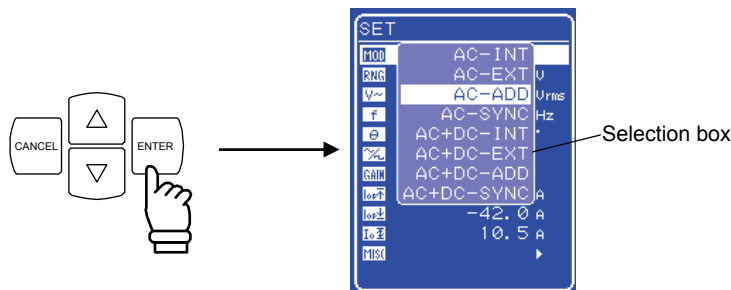

2. Press the  key to display the selection box.



3. Press the  or  key to move the cursor to the mode to be set.

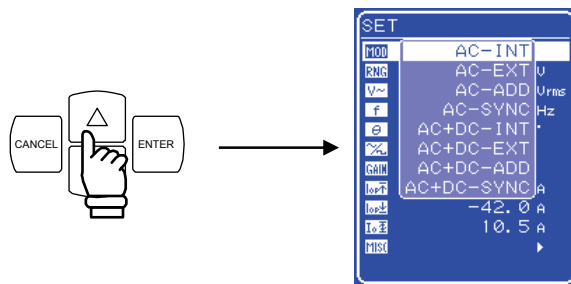

4. Press the  key to set the selected mode.

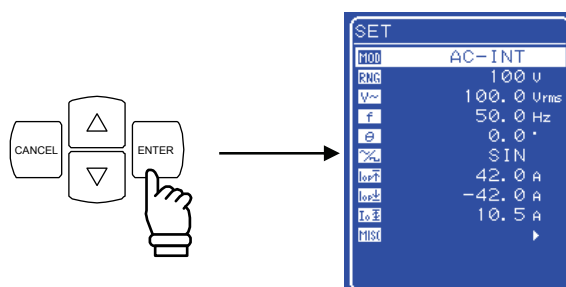

3.4.3 Setting output voltage range



Select 100 V or 200 V. The output voltage range cannot be changed while output is on.
The setting range varies according to the output voltage range.

Table 3-5. List of Setting Ranges for Various Output Voltage Range

Setting			Setting Range		
			100 V range	200 V range	Unit
DC voltage			-200.0 to +200.0	-400.0 to +400.0	V
AC voltage	Wave-form	SIN/SQU	0.0 to 140.0	0.0 to 280.0	Vrms
		ARB1 to 16	0.0 to 400.0	0.0 to 800.0	Vp-p
Output peak current limiter (positive)			+10.0 to +42.0	+5.0 to +21.0	A
Output peak current limiter (negative)			-42.0 to -10.0	-21.0 to -5.0	A
Output average current limiter			1.0 to 10.5	1.0 to 5.3	A
Positive voltage setting limit			+5.0 to +200.0	+10.0 to +400.0	V
Negative voltage setting limit			-200.0 to -5.0	-400.0 to -10.0	V
External input gain			0.0 to 200.0	0.0 to 400.0	times

■ Operation steps

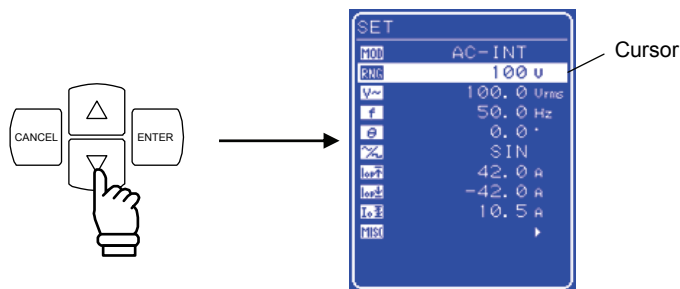

To set the output voltage range, select **RNG** in the SET menu.

1. Press the  or  key to move the cursor to the **RNG** icon.

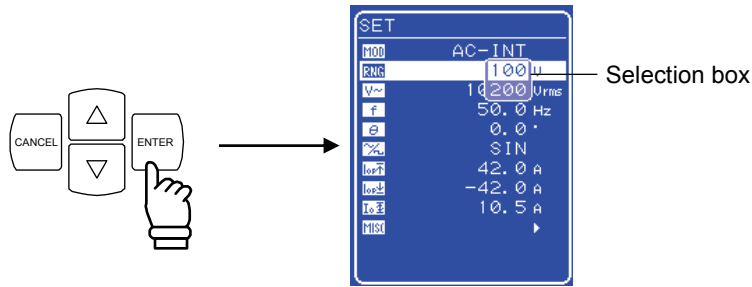

2. Press the  key to display the selection box.



3. Press the  or  key to move the cursor to the output voltage range to be selected.

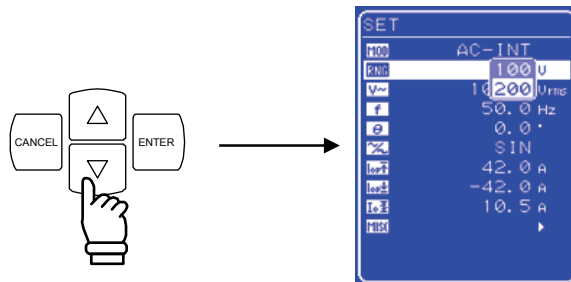

4. Press the  key. Then the **BUSY** icon appears in the status window.

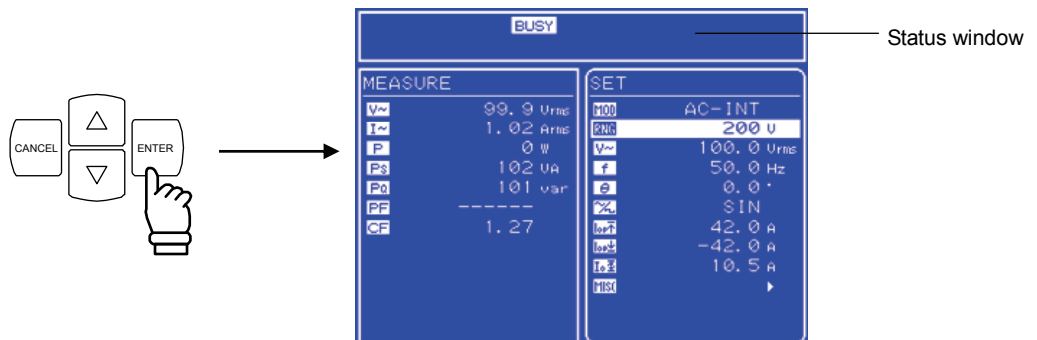

⇒ The **BUSY** icon goes out in a few seconds, then the display will change to the selected output voltage range.

* Changing the output voltage range takes about eight seconds.

3.4.4 Setting waveform

The APS-1102 allows to select a sine wave, square wave, or arbitrary waveform (16 types in all) as the waveform to be output, by using the control panel. Arbitrary waveforms are generated using data transfers via the USB interface.

☞ See “4.6 Output of Arbitrary Waveforms”, for details of arbitrary waveforms.



Table 3-6 lists the waveforms that can be selected.

Table 3-6. AC Voltage Waveform and AC Current Waveform List

As Shown in Operation Panel	Type
SIN	Sine wave
SQU	Square wave
ARB1 to ARB16	Arbitrary waveform (16 types)

■ **Operation steps**

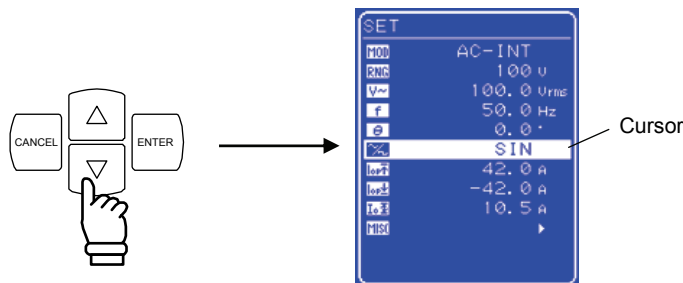

To select a waveform, select  in the SET menu.

1. Press the  or  key to move the cursor to the  icon.

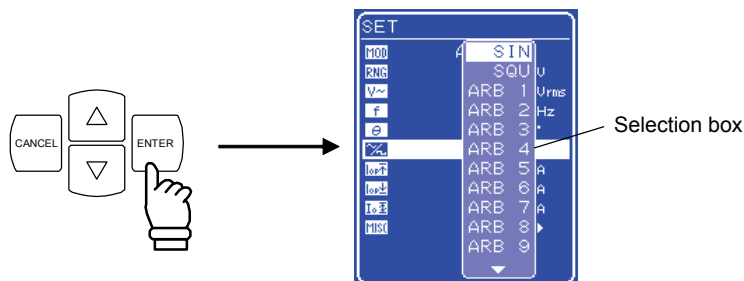

2. Press the  key to display the selection box.



3. Press the  or  key to move the cursor to the waveform to be output.

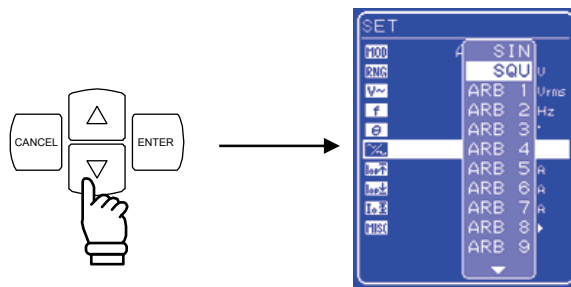

4. Press the  key to set the selected waveform.

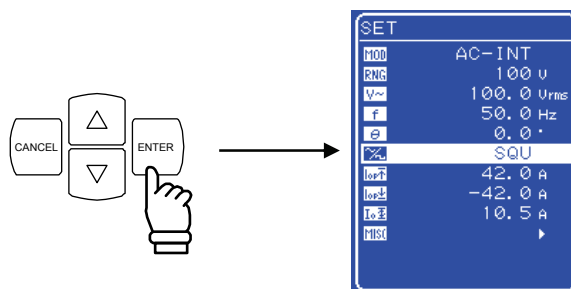



3.4.5 Setting output voltage

For AC-INT mode, the output voltage settings listed below can be selected.

Table 3-7. Output Voltage Settings



Output Mode	Setting		Setting Range	Resolution	
AC-INT (AC mode)	AC voltage	100 V range	SIN/SQU	0.0 to 140.0 Vrms	0.1 Vrms
			ARB1 to ARB 16	0.0 to 400.0 Vp-p	0.1 Vp-p
		200 V range	SIN/SQU	0.0 to 280.0 Vrms	0.1 Vrms
			ARB1 to ARB 16	0.0 to 800.0 Vp-p	0.1 Vp-p

 See “3.4.7 Using limiter functions”, when using a setting range limit for output voltage.

 See “5.3.3 Setting output voltage”, for output voltage setting ranges for other output modes.

■ **Operation steps**

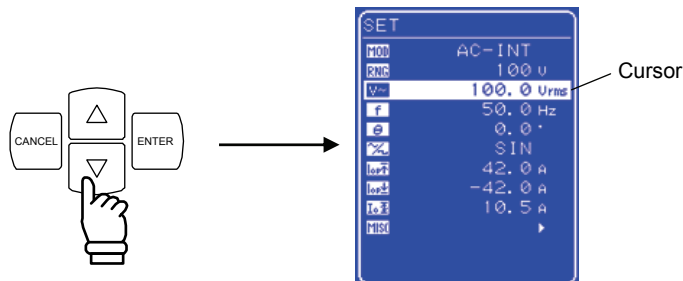

To set the output voltage, set  in the SET menu.

1. Press the  or  key to move the cursor to the  icon.



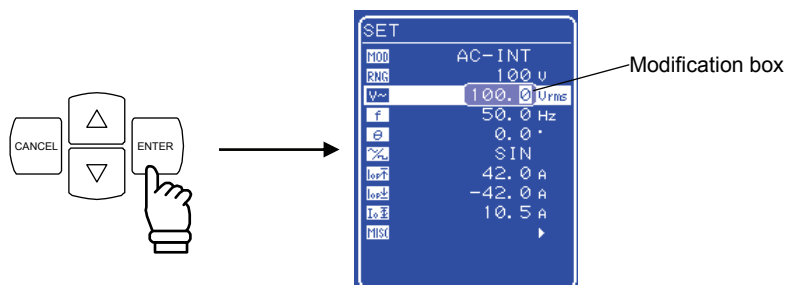

2. Press the  key to display the modification box.

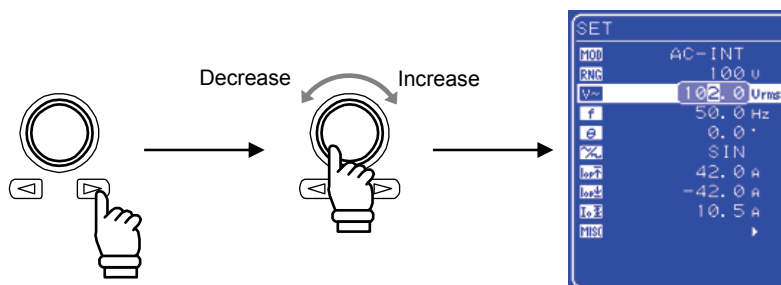

3. Press the  and  keys to move the cursor to the digit to be changed, turn the MODIFY dial and set a numerical value. The set value will be reflected in output immediately.



4. Press the  or  key to close the modification box.

3.4.6 Setting output frequency

The AC output frequency can be set in the following range.



Table 3-8. Output Frequency Setting

Setting Range	Resolution	Setting Accuracy
1.0 Hz to 550.0 Hz	0.1 Hz	±100 ppm (1.0 Hz to 550.0 Hz, 23 ±5°C)

☞ See “3.4.7 Using limiter functions”, when using an output frequency setting range limit.

■ Operation steps

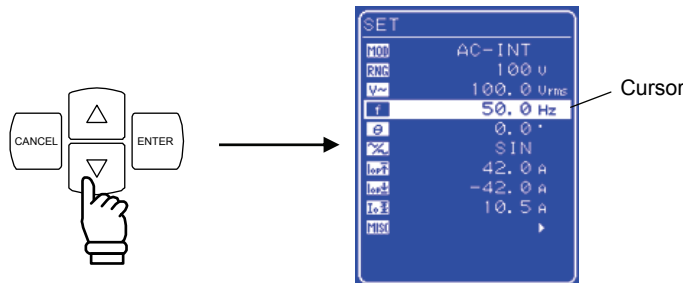

To set the output frequency, set a numerical value labeled **f** in the SET menu.

1. Press the  or  key to move the cursor to the **f** icon.



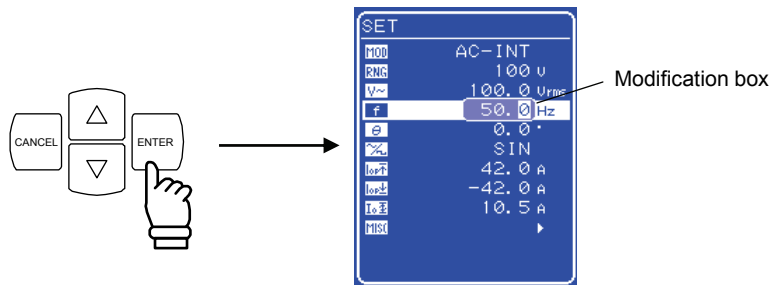

2. Press the  key to display the modification box.

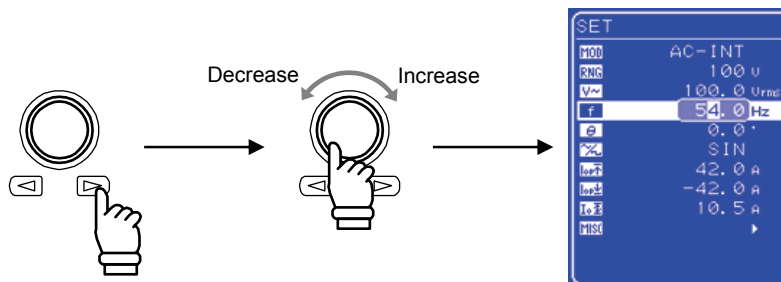

3. Press the  and  keys to move the cursor to the digit to be changed, turn the MODIFY dial and set a numerical value. The set value will be reflected in output immediately.



4. Press the  or  key to close the modification box.

3.4.7 Using limiter functions

a) Using current limiter

The APS-1102 includes an output peak current limiter function and an output average current limiter function.

Limiter settings are retained separately for 100 V and 200 V ranges.

Setting range limits can be set for output voltage and output frequency.

 See “5.3.7 Set Output peak current limiter settings”.

 See “5.3.8 Set Output average current limiter settings”.

Table 3-9. Current Limiter Setting Ranges

Setting		Setting Range	Resolution	Initial Value
Output peak current limiter (positive)	100 V range	+10.0 A to +42.0 A	0.1 A	+42.0 A
	200 V range	+5.0 A to +21.0 A	0.1 A	+21.0 A
Output peak current limiter (negative)	100 V range	-42.0 A to -10.0 A	0.1 A	-42.0 A
	200 V range	-21.0 A to -5.0 A	0.1 A	-21.0 A
Output average current limiter	100 V range	1.0 A to 10.5 A	0.1 A	10.5 A
	200 V range	1.0 A to 5.3 A	0.1 A	5.3 A

For a capacitive load or inductive load, the output peak current limiter may not achieve the peak current value as set, due to overshooting or undershooting the set current value, or variable output current waveforms while the limiter is operating.

For an inductive load, operation of the limiter can cause the current to vary and, as a result, an output overvoltage may occur.

CAUTION

Note with caution that the output peak current limiter may allow overshooting, depending on the load, and therefore may not achieve the peak current value as set.



For an inductive load, operation of the limiter can cause an output overvoltage, triggering the overvoltage protection function. In this case, the peak current limiter settings (positive and negative) should be reduced.





CAUTION

If the output current or frequency suddenly increases, due to an output short, etc., the limiter response may not be quick enough, so the output overcurrent protection function may be triggered.

■ **Operation steps**

Select the icon in the SET menu corresponding to the desired setting, then set a numerical value.

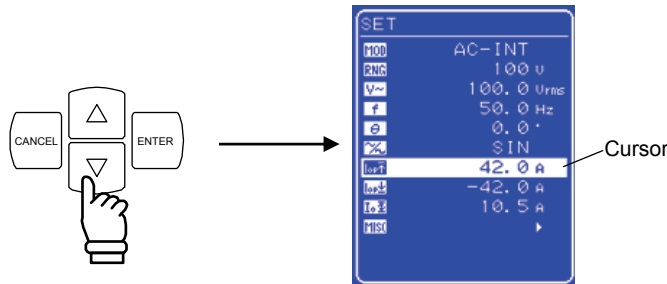

- Output peak current limiter (positive): 
- Output peak current limiter (negative): 
- Output average current limiter: 

1. Press the  or  key to move the cursor to the  or  or  icon.



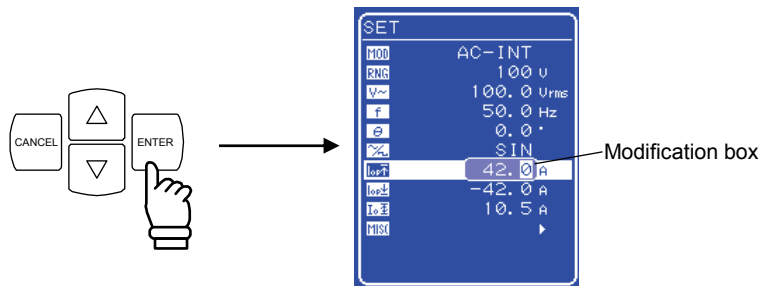

2. Press the  key to display the modification box.

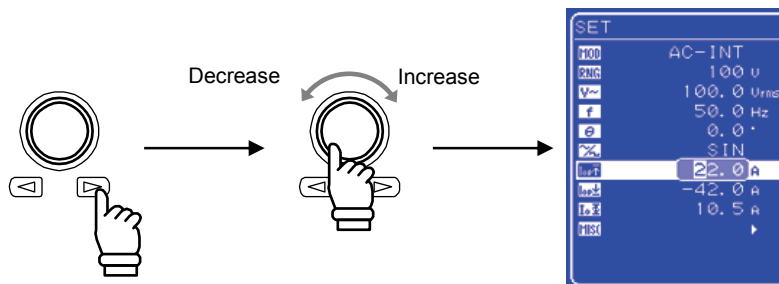

3. Press the  and  keys to move the cursor to the digit to be changed, turn the MODIFY dial and set a numerical value. The set value will be reflected in output immediately.



4. Press the  or  key to close the modification box.

b) Using setting range limiter

The APS-1102 internal mode (AC-INT, AC+DC-INT) and internal + external mode (AC-ADD, AC+DC-ADD) include setting range limiter functions for output voltage and output frequency.



☞ See “5.5.5 Setting range limiter (LIMIT)”, for details.

Table 3-10. Voltage and Frequency Setting Range Limiter

Setting		Setting Range	Resolution	Initial Value
Positive voltage setting limit	100 V range	+5.0 V to +200.0 V	0.1 V	+200.0 V
	200 V range	+10.0 V to +400.0 V	0.1 V	+400.0 V
Negative voltage setting limit	100 V range	-200.0 V to -5.0 V	0.1 V	-200.0 V
	200 V range	-400.0 V to -10.0 V	0.1 V	-400.0 V
Frequency upper limit setting limit		1.0 Hz to 550.0 Hz	0.1 Hz	550.0 Hz
Frequency lower limit setting limit		1.0 Hz to 550.0 Hz	0.1 Hz	1.0 Hz



■ Operation steps

The setting range limit is set via the LIMIT screen under the MISC menu .

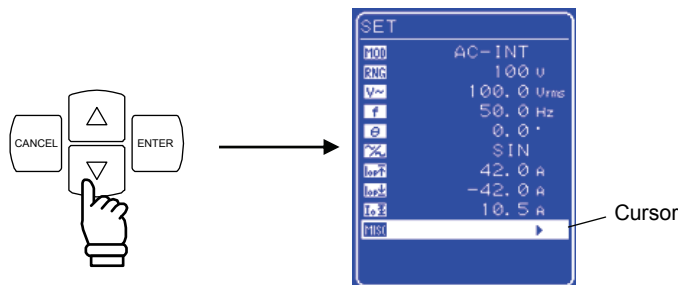
1. Press the  or  key to move the cursor to the  icon.



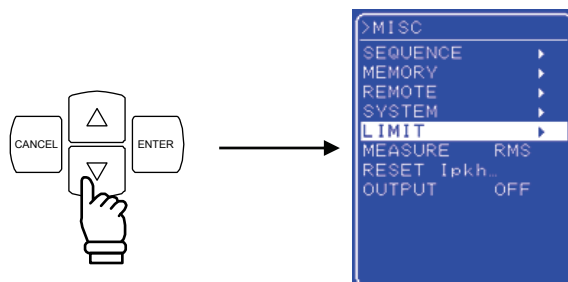

2. Press the  key to display the MISC menu.

Press the  or  to move the cursor key to “LIMIT”.

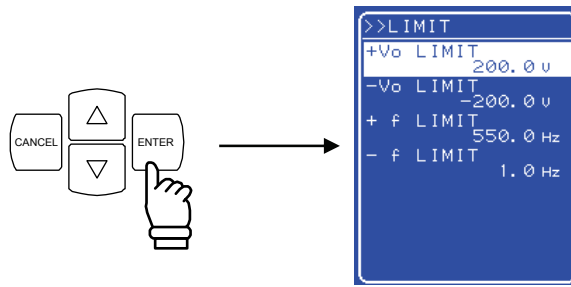

3. Press the  key to display the LIMIT screen .



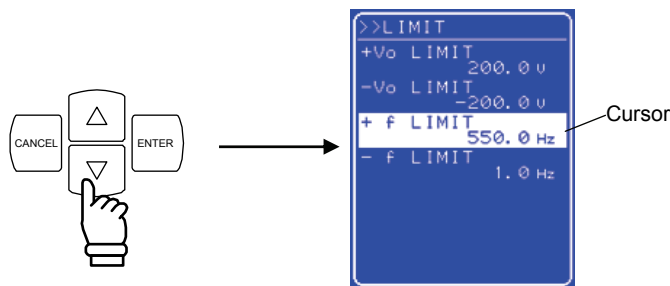

4. Press the  or  key to move the cursor to the item to be set.

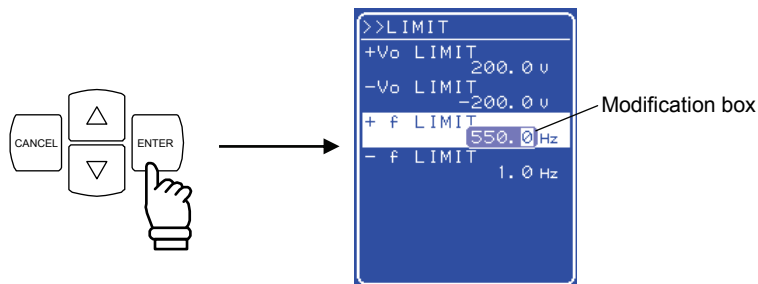

5. Press the  key to display the modification box.



6. Press the  and  keys to move the cursor to the digit to be changed, turn the MODIFY dial and set a numerical value. The set value will be reflected in output immediately.

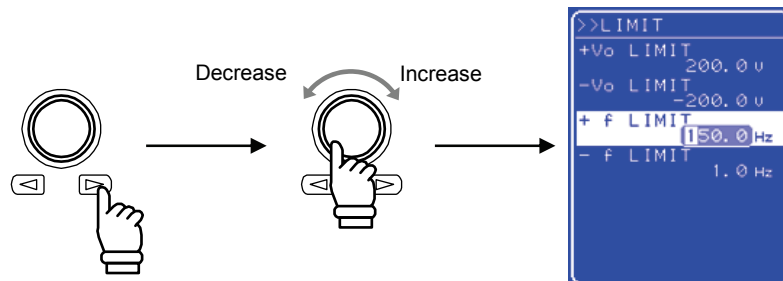

7. After setting all of the items, press the  or  key to close the modification box.

3.4.8 Output on/off

To turn the APS-1102 output on or off, simply press the  key.

When output is on, the output on/off LED goes on, and it goes off when the output is off.

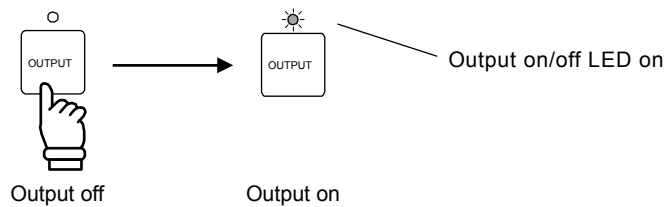

⚠ WARNING

To ensure safety, make sure the power is off before connecting outputs.

⚠ CAUTION

Before turning off the power, make sure that the output on/off LED is off.

The output on/off setting can be controlled via the MISC menu of the display.

 See “5.5.8 Output on/off”.

3.4.9 Using measurement functions

The APS-1102 is equipped with the following measurement functions.

- Voltage (RMS, average DC, peak)
- Current (RMS, average DC, peak, peak hold)
- Power (effective, reactive, apparent)
- Synchronization frequency (external synchronization)
- Load power factor
- Load crest factor
- Harmonic current (50/60 Hz fundamental, up to 40th harmonics)

Measured values are displayed in the measured value window MEASURE screen, which enables the output status to be monitored.

a) Measured value window



Figure 3-12. Example of Measured Value Window (AC-INT Mode)

When a measurement is out of range, “-----” is displayed in the numerical value field.



b) Select measurement display

Select among RMS, AVG, PEAK, or harmonic current as the measured current and voltage values to be displayed.

⇒  See “4.3 Measurement of Harmonic Current”, for description of harmonic current measurements.



■ **Operation steps**

To select a measurement display, select “MEASURE” in the MISC menu .

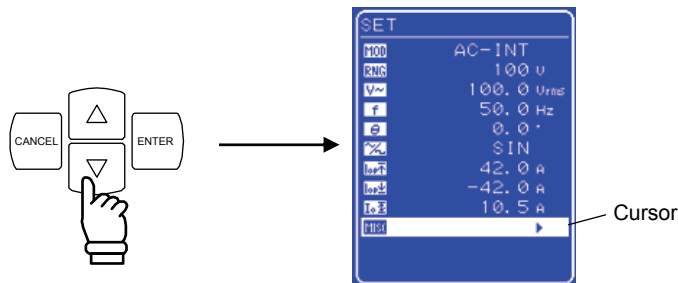
1. Press the  or  key to move the cursor to the  icon.



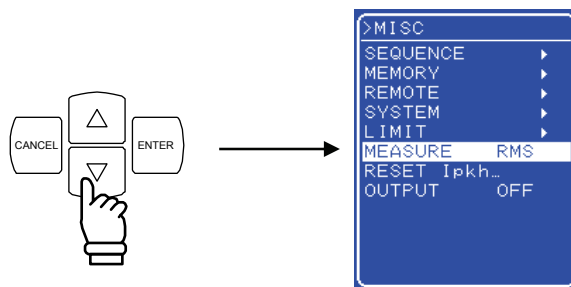

2. Press the  key to display the MISC menu.

Press the  or  key to move the cursor to “MEASURE”.

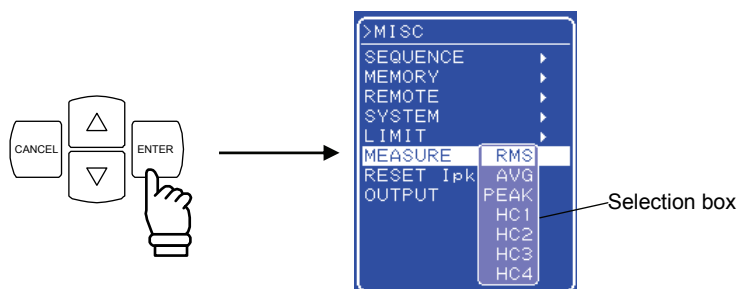

3. Press the  key to display the selection box.



4. Press the  or  key to move the cursor to the desired measurement display.

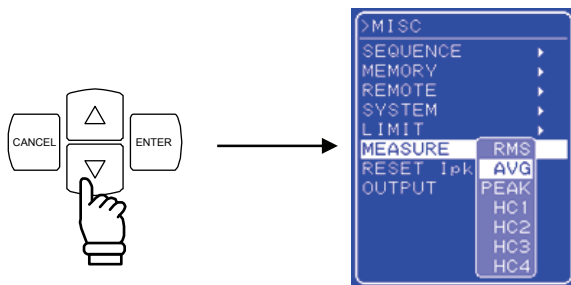

HC1 to HC4 are for measuring harmonic current.

 See “4.3 Measurement of Harmonic Current”.

5. Press the  key to set the selected measurement display.

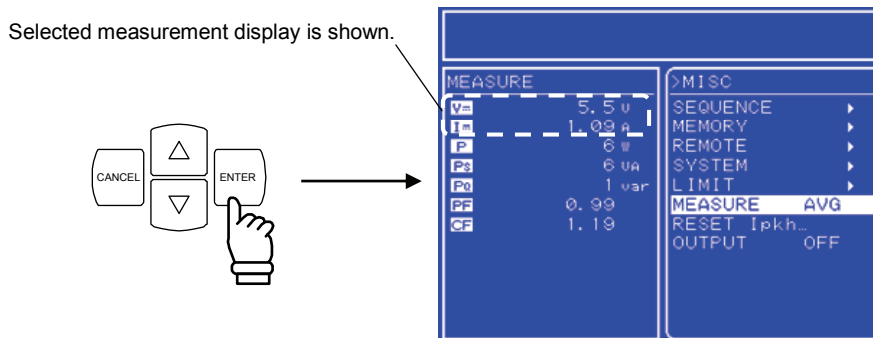

6. Press the TOP MENU key or CANCEL key to return to the SET menu screen.

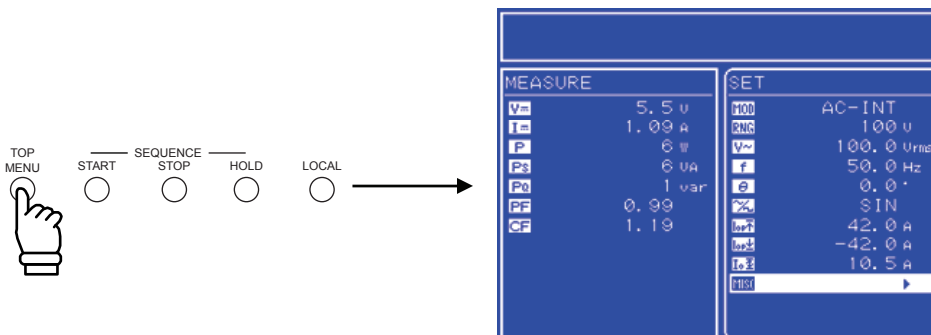

3.5 Output Characteristics

The following charts show output voltage vs. output current of the APS-1102 (resistance load, typical character).

Figures 3-13 and **3-14** show charts when AC is input, and **Figures 3-15** and **3-16** show when DC is input.

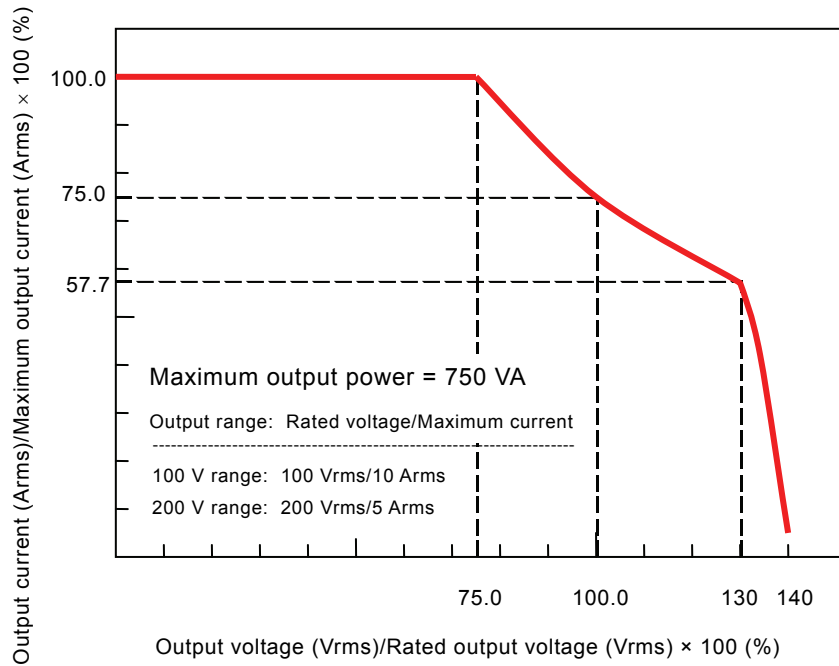

Figure 3-13. Output Voltage vs. Output Current Characteristics (100 V AC Input, AC-INT)

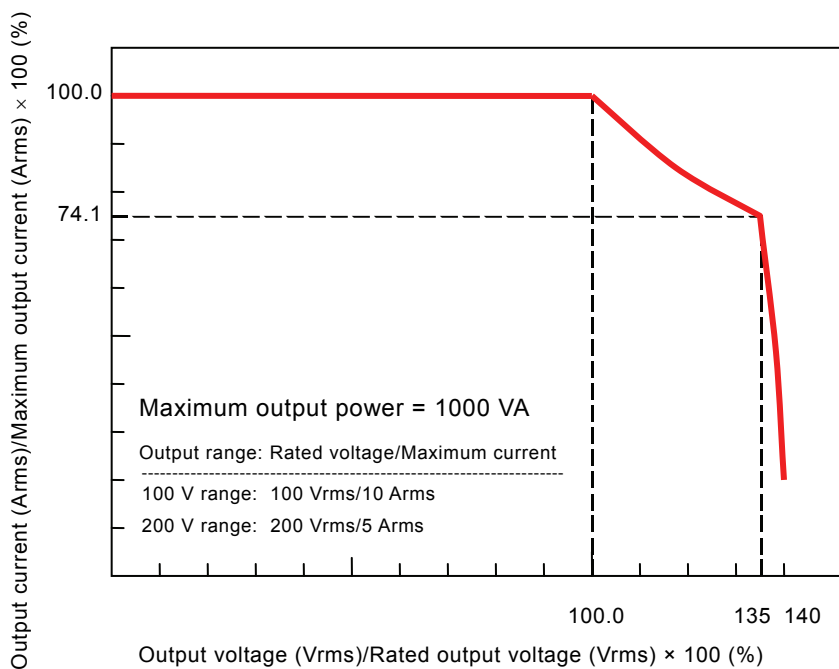

Figure 3-14. Output Voltage vs. Output Current Characteristics (200 V AC Input, AC-INT)

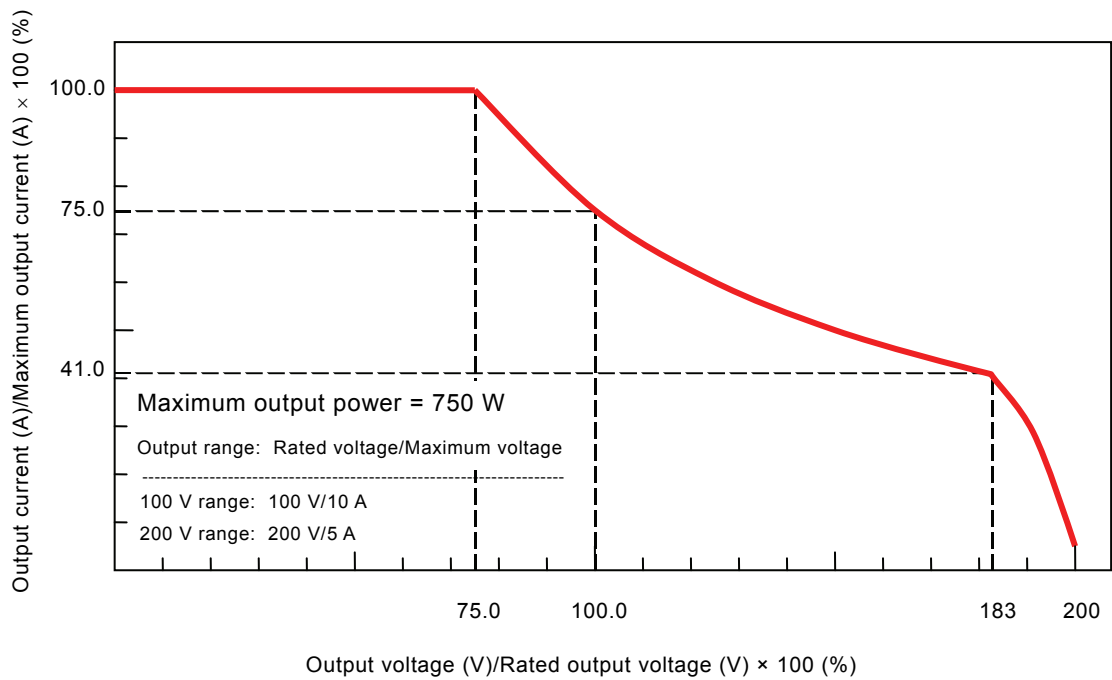

Figure 3-15. Output Voltage vs. Output Current Characteristics (100 V AC Input, AC+DC-INT, AC=0)

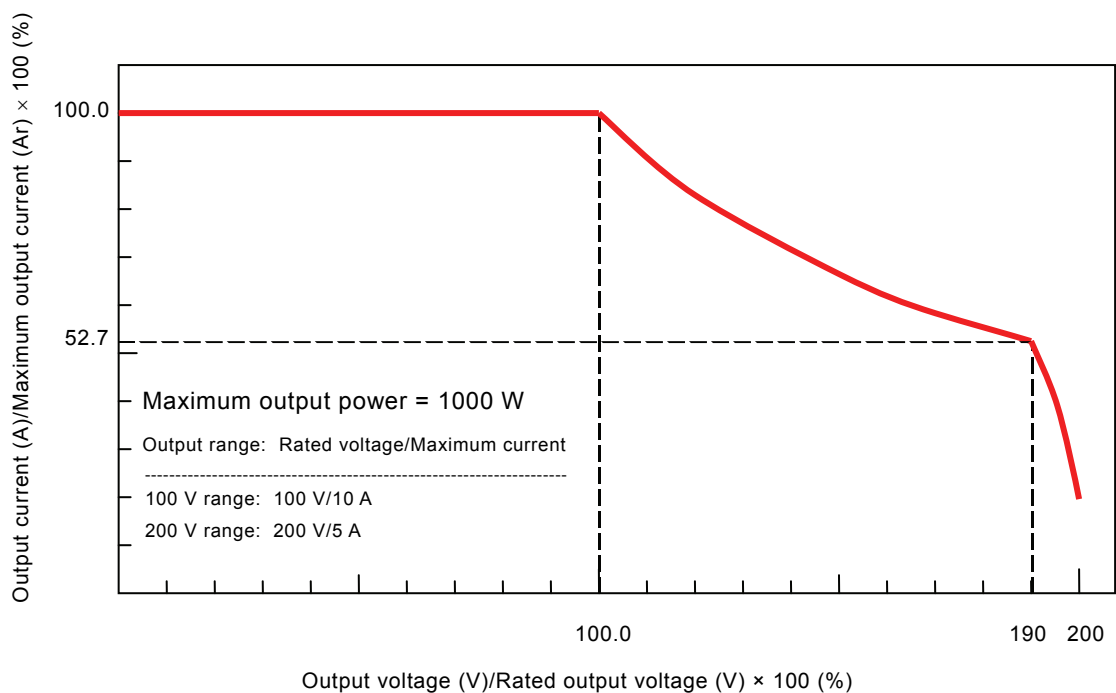

Figure 3-16. Output Voltage vs. Output Current Characteristics (200 V AC Input, AC+DC-INT, AC=0)

4. **A**DVANCED OPERATION EXAMPLE

4.1	Use as a DC Power Source	4-2
4.1.1	Connecting output terminal to load during DC output	4-2
4.1.2	Selecting an output mode (AC+DC-INT mode)	4-3
4.1.3	Setting the output voltage range	4-5
4.1.4	Setting the output voltage	4-7
4.1.5	Setting output frequency of superimposed AC	4-9
4.1.6	Setting superimposed AC waveform	4-10
4.1.7	Use measurement function	4-11
4.2	Measurement of Inrush Current	4-14
4.2.1	Inrush current	4-14
4.2.2	Set phase at output on	4-15
4.2.3	Set measurement display to peak value	4-16
4.2.4	Reset the peak current hold value	4-17
4.3	Measurement of Harmonic Current	4-19
4.4	Using the Sequence Function	4-21
4.4.1	Sequence operations	4-21
4.4.2	Sequence settings	4-28
4.4.3	Programming sequences	4-30
4.4.4	Control of sequence operations	4-36
4.4.5	Clear sequence memory	4-38
4.4.6	Example of sequence operation settings	4-39
4.4.7	Execution of sequence operations	4-43
4.5	Control Using External Control I/O Connector	4-47
4.6	Output of Arbitrary Waveforms	4-48
4.7	Synchronization of Output to External Signal	4-50
4.7.1	External signal synchronization	4-51
4.7.2	Line synchronization	4-53
4.8	Using Memory Functions	4-53
4.9	Amplification of External Signal	4-57
4.10	Adding External Signals and Internal Signals	4-61

4.1 Use as a DC Power Source

When using the APS-1102 as a DC voltage source, select DC - Internal signal mode (AC+DC-INT), then enter the settings listed in **Table 4-1**.

AC components (sine wave, square wave, and arbitrary waveform) can be superimposed on the DC power source.

A protection diode may be required to be connected, depending on the load, such as a capacitor or inductor.

Table 4-1. Panel Settings When Using APS-1102 as a DC Power Source

Setting		Setting Range	Resolution	Initial Value	
DC voltage	100 V range	-200.0 to +200.0 V	0.1 V	0.0 V	
	200 V range	-400.0 to +400.0 V	0.1 V	0.0 V	
AC voltage	100 V range	SIN/SQU	0.0 to 140.0 Vrms	0.1 Vrms	0.0 Vrms
		ARB1 to ARB16	0.0 to 400.0 Vp-p	0.1 Vp-p	0.0 Vp-p
	200 V range	SIN/SQU	0.0 to 280.0 Vrms	0.1 Vrms	0.0 Vrms
		ARB1 to ARB16	0.0 to 800.0 Vp-p	0.1 Vp-p	0.0 Vp-p
AC voltage frequency		1.0 to 550.0 Hz	0.1 Hz	50.0 Hz	
Phase when output is on		0.0 to 359.9°	0.1°	0.0°	

The unit for AC voltage settings differs according to the AC voltage waveform setting.

4.1.1 Connecting output terminal to load during DC output

Use the output terminal on the rear panel when outputting DC+AC or only DC from the APS-1102. If the load is a capacitor or inductive load, connect a diode for protection that meets the following specifications between the output terminal of the APS-1102 and the load.

- Maximum reverse voltage: 600 V or higher
- Maximum forward current: 15 A or more (100 V range), 7.5 A or more (200 V range)

a) Capacitive load such as capacitor (about 50 μ F or more) and DC-DC converter

When a capacitive load is charged, the greater the voltage changes, the more the charge current becomes. Overshoot may be generated in the output currents depending on the load, even if the peak current limiter of the APS-1102 operates, thus turning off the output due to overcurrent protection.

To avoid this, gradually lower the set voltage so that decrease of the voltage changes per certain unit time or use the sweep function of the sequence.

A block diode is required to prevent current from flowing from the load to the output terminal of the APS-1102 even if the output voltage is lowered. Connect the diode and the load serially as shown in **Figure 4-1**.

Once a diode has been connected, a load that does not consume power keeps its voltage charged. The voltage of the load may be slightly higher due to the overshoot voltage and should be carefully monitored.

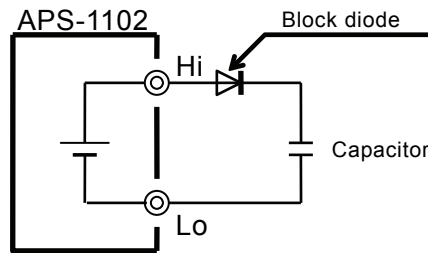

Figure 4-1. Connection of Block Diode

b) Inductive load such as inductor

An inductive load generates a back EMF when current suddenly stops flowing, such as when the output is turned off. A backflow diode is required to absorb the back EMF.

Connect a backflow diode in parallel with the load, as shown in **Figure 4-2**.

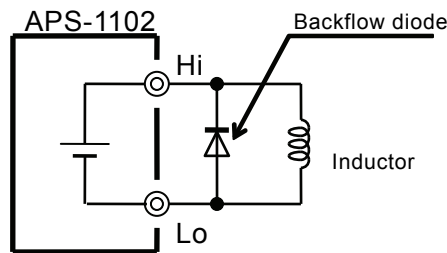



Figure 4-2. Connection of Backflow Diode

4.1.2 Selecting an output mode (AC+DC-INT mode)

To select an output mode, select **M00** in the SET menu.

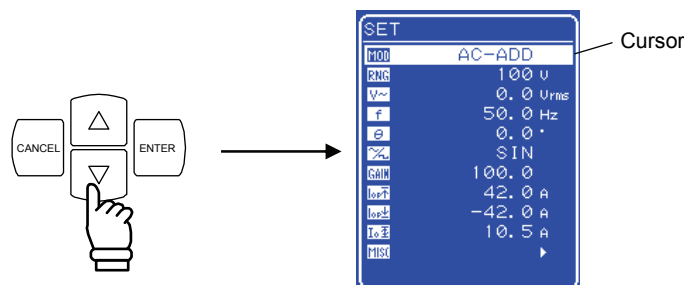

■ Operation steps

1. Press the  or  key to move the cursor to the **M00** icon.

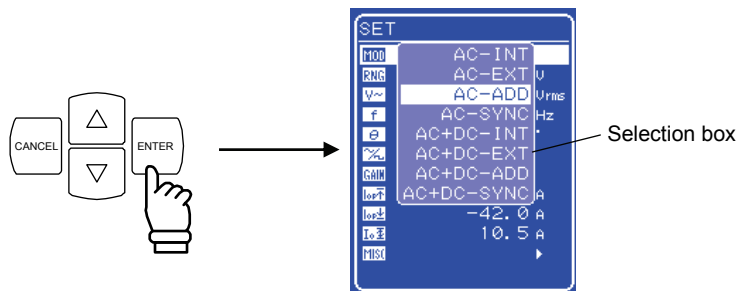

2. Press the  key to display the selection box.



3. Press the  or  key to move the cursor to "AC+DC-INT".

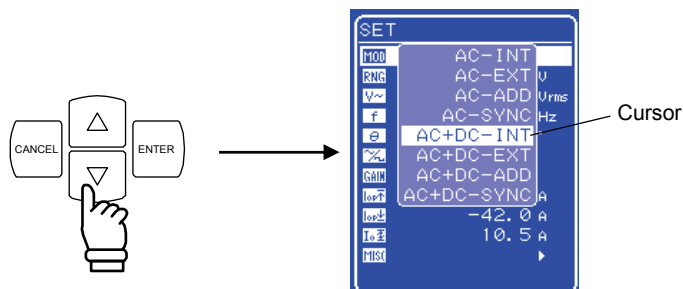

4. Press the  key to set the AC+DC-INT mode.

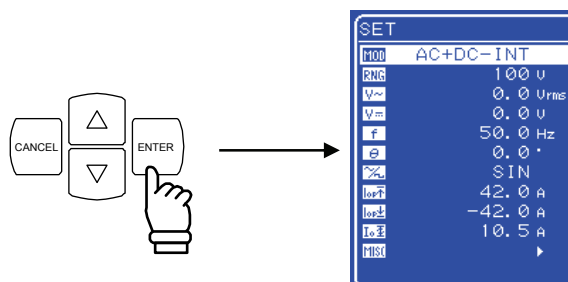

4.1.3 Setting the output voltage range

Select 100 V or 200 V as the output voltage range.



As is shown in **Table 4-2**, the range that can be set for the output voltage differs according to the selected output voltage range.

Table 4-2. Setting Range Options for Various Output Voltage Ranges

Setting		Setting range		
		100 V range	200 V range	Unit
DC voltage		-200.0 to +200.0	-400.0 to +400.0	V
AC voltage	SIN/SQU	0.0 to 140.0	0.0 to 280.0	V _{rms}
	ARB1 to ARB16	0.0 to 400.0	0.0 to 800.0	V _{p-p}
Output peak current limiter (positive)		+10.0 to +42.0	+5.0 to +21.0	A
Output peak current limiter (negative)		-42.0 to -10.0	-21.0 to -5.0	A
Output average current limiter		1.0 to 10.5	1.0 to 5.3	A
Positive voltage setting limit		+5.0 to +200.0	+10.0 to +400.0	V
Negative voltage setting limit		-200.0 to -5.0	-400.0 to -10.0	V
External input gain		0.0 to 200.0	0.0 to 400.0	times

To select an output voltage range, select  in the SET menu.
The output voltage range cannot be changed when output is on.

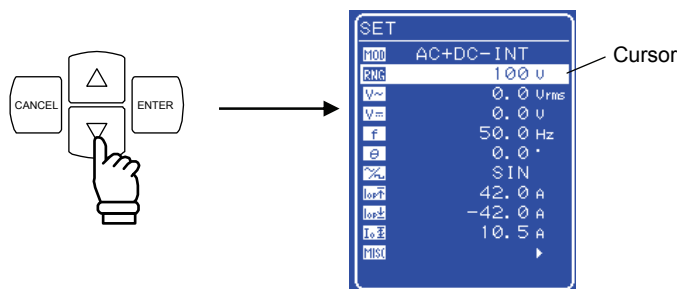

■ Operation steps

1. Press the  or  key to move the cursor to the  icon.

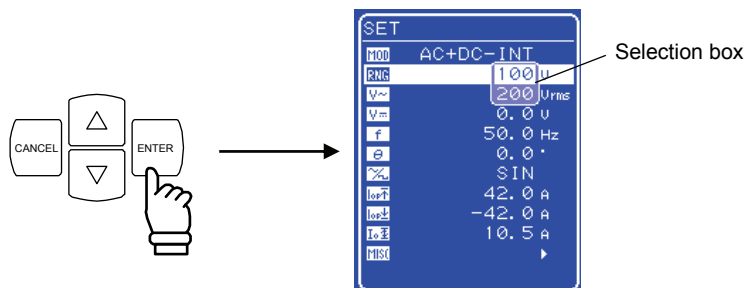

2. Press the  key to display the selection box.



3. Press the  or  key to move the cursor to 100 V or 200 V.

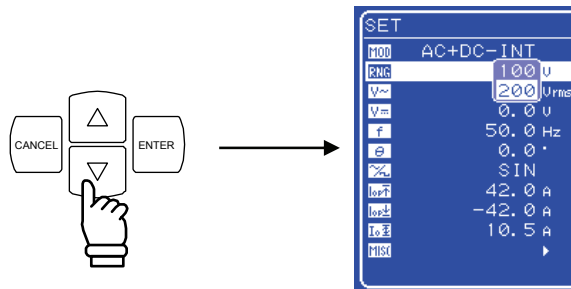

4. Press the  key. Then the **BUSY** icon appears in the status window .

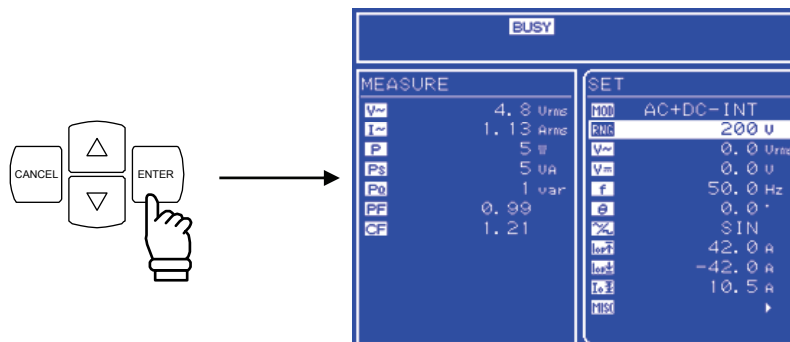

⇒ The **BUSY** icon goes out in a few seconds, then the output voltage range changes to the selected range.

* Changing the output voltage range takes about eight seconds.

4.1.4 Setting the output voltage

The ranges that can be set are listed below.



Table 4-3. Output Voltage Setting Ranges When AC+DC Mode Is Selected

Setting		Setting range	resolution
DC voltage	100 V range	-200.0 to +200.0 V	0.1 V
	200 V range	-400.0 to +400.0 V	0.1 V
AC voltage	100 V range	SIN/SQU	0.0 to 140.0 Vrms
		ARB1 to ARB16	0.0 to 400.0 Vp-p
	200 V range	SIN/SQU	0.0 to 280.0 Vrms
		ARB1 to ARB16	0.0 to 800.0 Vp-p





Output can be set so that AC voltage is superimposed on DC voltage.

The unit for AC voltage settings differs according to the AC voltage waveform setting.

When the selected AC voltage waveform is SIN/SQU, the AC voltage setting is in Vrms units, and when it is ARB1 to ARB16, the setting is in Vp-p units.

To select an output voltage, select  “DC voltage” or  “AC voltage” in the SET menu, then set a numerical value.

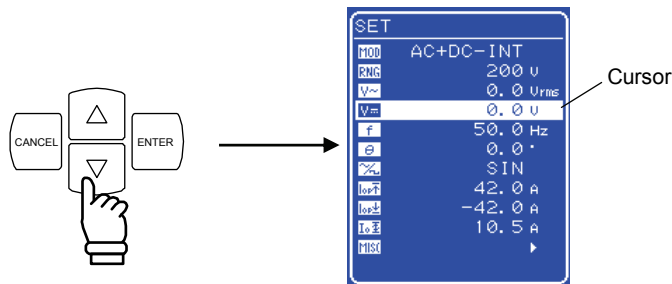

■ Operation steps

1. Press the  or  key to move the cursor to the  or  icon.



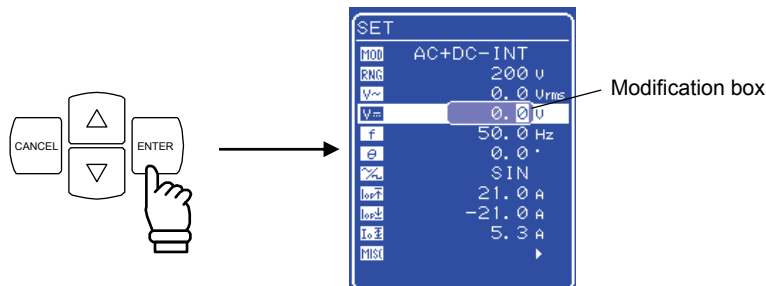

2. Press the  key to display the modification box.

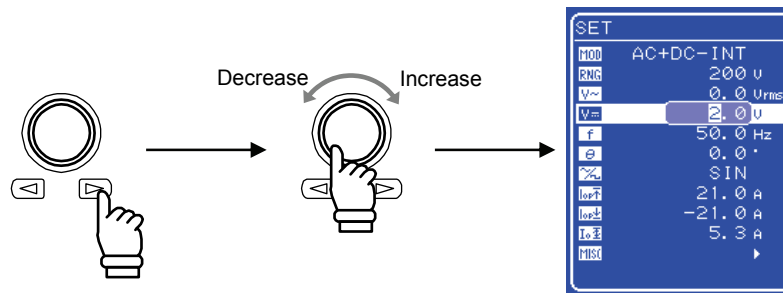

3. Press the  and  keys to move the cursor to the digit to be changed, turn the MODIFY dial and set a numerical value. The set value will be reflected in output immediately.





4. Press the  or  key to close the modification box.

4.1.5 Setting output frequency of superimposed AC

To set the output frequency, set a numerical value under **f** in the SET menu.

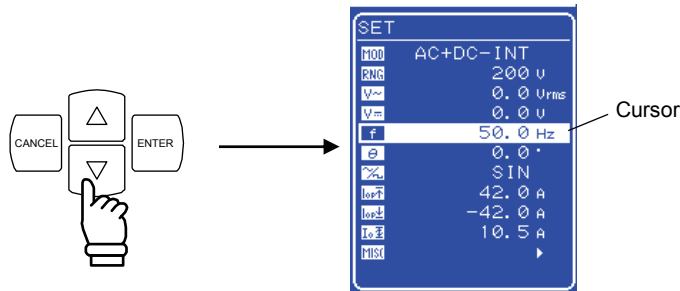

■ Operation steps

1. Press the  or  key to move the cursor to the **f** icon.



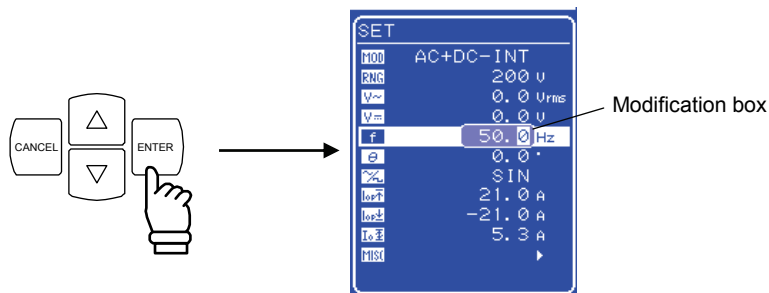

2. Press the  key to display the modification box.

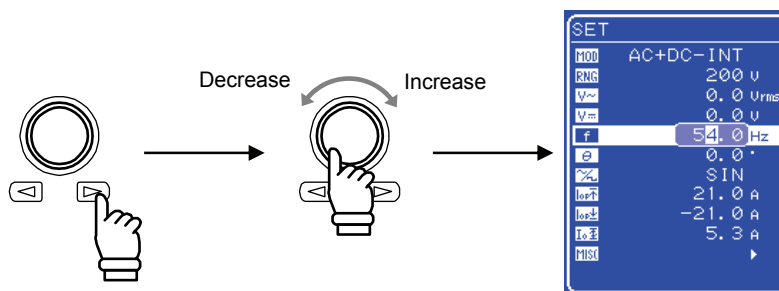

3. Press the  and  keys to move the cursor to the digit to be changed, turn the MODIFY dial and set a numerical value. The set value will be reflected in output immediately.



4. Press the  or  key to close the modification box.

4.1.6 Setting superimposed AC waveform

Selects among 16 types of sine waves (SIN), square waves (SQU), and arbitrary waveforms (ARB). Arbitrary waveforms are generated using data transfers via the USB interface.

See “4.6 Output of Arbitrary Waveforms”, for details of arbitrary waveforms.

To select a waveform, select in the SET menu.

■ Operation steps

1. Press the or key to move the cursor to the icon.

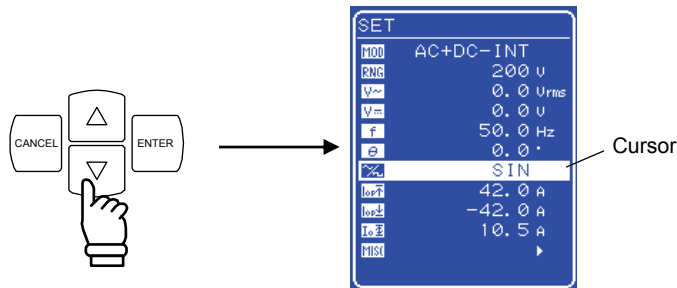

2. Press the key to display the selection box.

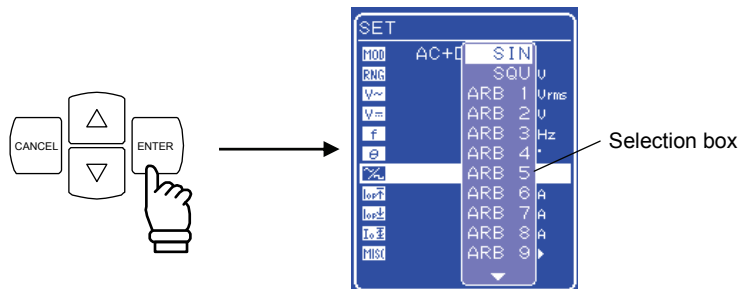

3. Press the or key to move the cursor to the waveform to be output.

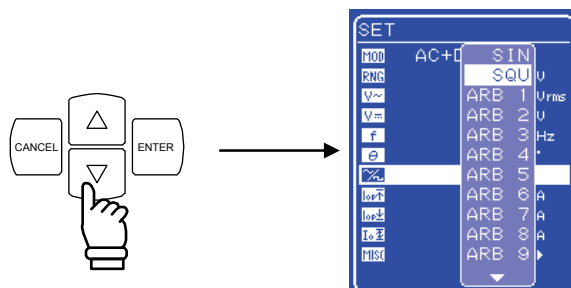

4. Press the  key to set the selected waveform.

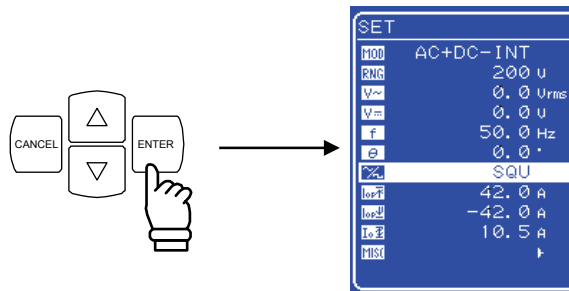

4.1.7 Use measurement function

Measured values are displayed in the measured value window MEASURE screen, which enables the output status to be monitored.

a) Measured value window



Figure 4-3. Example of Measured Value Window (During AC+DC Mode)



When a measurement is out of range, “-----” is displayed in the numerical value field. Select “AVG” to measure DC component only, or select “RMS” to measure the superimposed value of DC and AC components.

b) Select measurement display

Select one form among RMS, AVG, or PEAK as the measured current and voltage values to be displayed.



To select a measurement display, select “MEASURE” in the MISC menu .

■ Operation steps

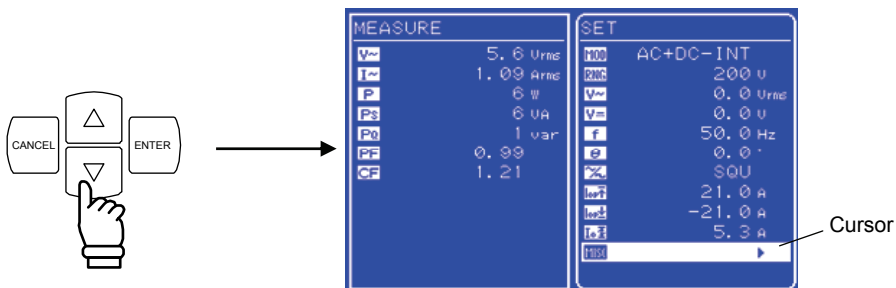
1. Press the  or  key to move the cursor to the  icon.



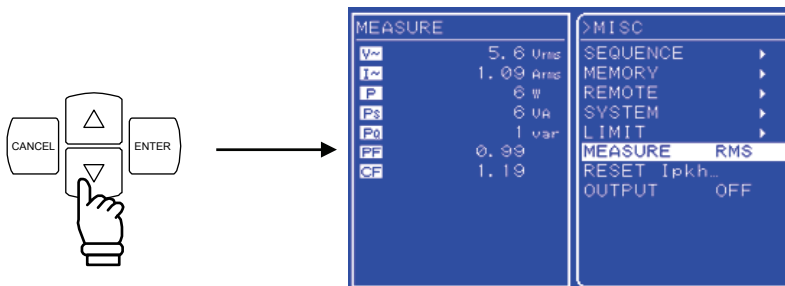

2. Press the  key to display the MISC menu.

Press the  or  key to move the cursor to “MEASURE”.

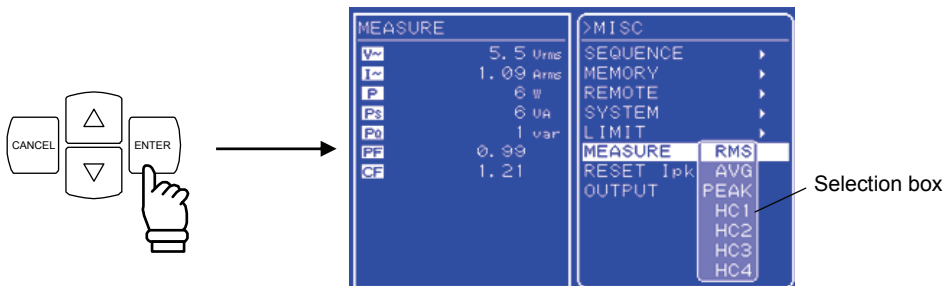

3. Press the  key to display the selection box.



- Press the  or  key to move the cursor to the desired measurement display.
Select “AVG” to measure only the DC power source.

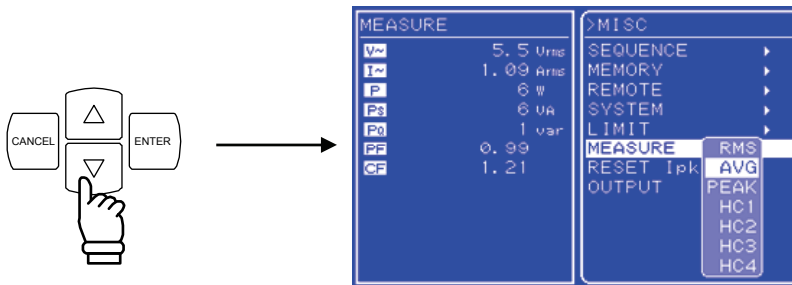

- Press the  key to set the selected measurement display.

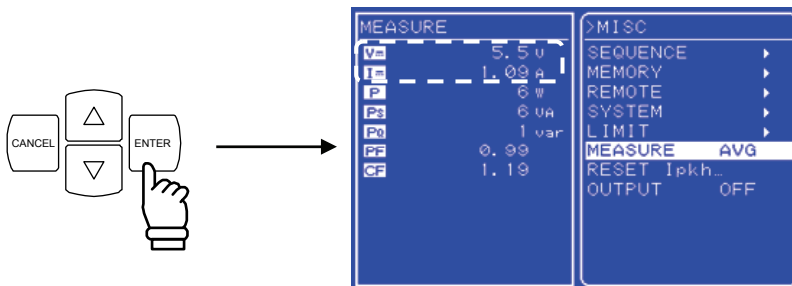

Although harmonic current measurement (HC1 to HC4) is also displayed in the selection box, this cannot be selected when in AC+DC mode. When in AC internal mode (AC-INT), harmonic current measurement can be selected only when the frequency setting is 50.0 Hz or 60.0 Hz.

 See “4.3 Measurement of Harmonic Current”.

- Press the TOP MENU key or CANCEL key to return to the SET menu screen.

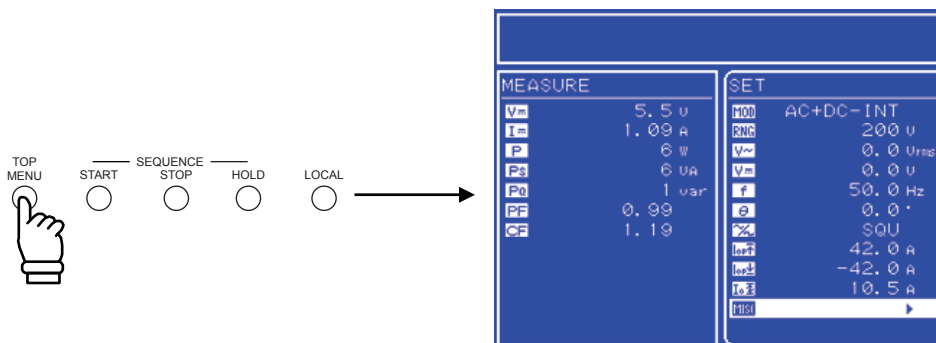

4.2 Measurement of Inrush Current

4.2.1 Inrush current

In such an electrical product as contains a capacitor input type rectifier circuit for the input power line, a current that is larger than the rated current may flow for a short time immediately after the power source switch is turned on. This current is called an “inrush current.”

If the power source is not able to supply such a large current, enough power is not supplied to the product, and sometimes it does not start in the worst case.

On the other hand, when such a large current passes through the power source line, the supply voltage is likely to decrease because of the voltage drop at the line impedance. There exists a standard to limit this effect within a certain level.

Such a product should be driven by a power source with enough supply capacity

- * Example of an inrush current
- An electric drill
- (rated 100 V AC/380 W)
- Upper: Voltage (100 V/div)
- Lower: Inrush current (10 A/div)

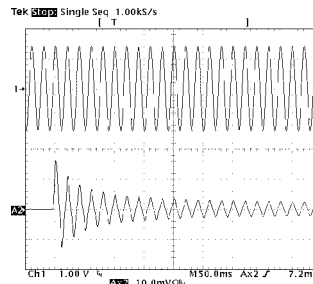

Even in a small electric drill, an inrush current of 15 Apk flows right after the power source is turned on. Since the rated current is 3.8 A, this represents a fourfold increase in the current flow.

The APS-1102 can supply four times as a large peaked current as the rated current supporting such a usage. There is no need to use a power source with an extra large capacity in order to supply the inrush current (for a capacitor input circuit of $CF = 4$ or less).

The initial phase of the output AC voltage is adjustable from 0.0° to 359.9° (in 0.1° steps), so the user can monitor how the current rushes in the load under various phase conditions. The peak current hold measurement function enables the measurement of the maximum peak value for the current flowing at that time.



When measuring the inrush current, set the peak current limiter to the maximum value. If the limiter setting is lowered, the inrush current measurement may be incorrect.

4.2.2 Set phase at output on

To set the phase at output on, select  “Phase at output on” in the SET menu and set a numerical value.

Before changing the phase at output on, set output off.

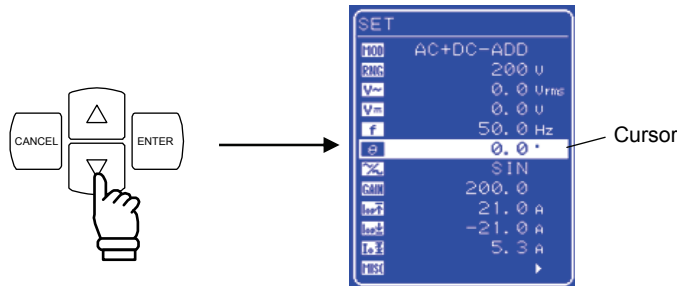

■ **Operation steps**

1. Press the  or  key to move the cursor to the  icon.



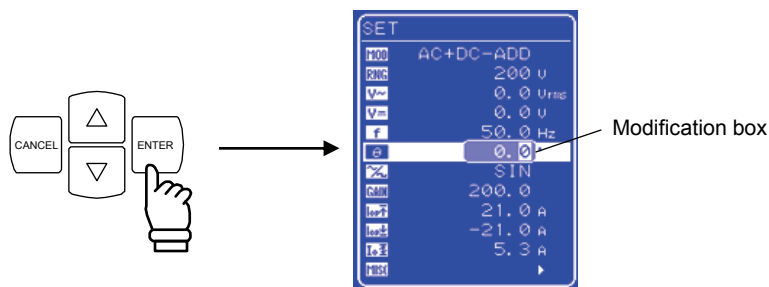

2. Press the  key to display the modification box.

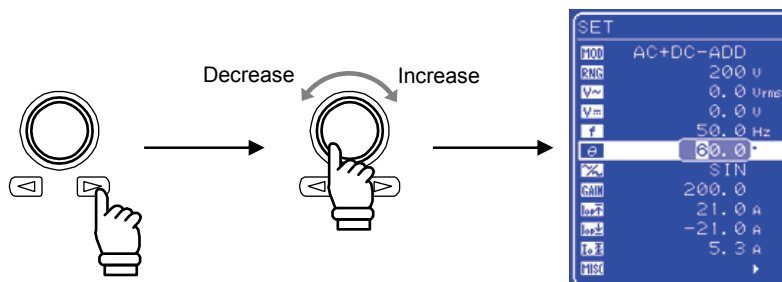

3. Press the  and  keys to move the cursor to the digit to be changed, turn the MODIFY dial and set a numerical value. The set value will be reflected in output immediately.







4. Press the  or  key to close the modification box.

4.2.3 Set measurement display to peak value

Set the displayed current measurement value to the peak value (PEAK).



To change the displayed current measurement value, select “MEASURE” in the MISC menu .

■ **Operation steps**

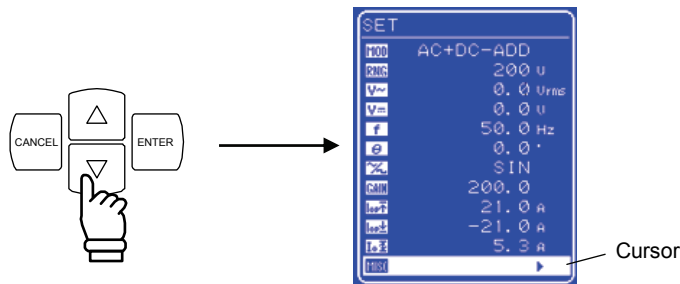
1. Press the  or  key to move the cursor to the  icon, then press the  key.





⇒ The MISC menu is displayed.

2. Press the  or  key to move the cursor to “MEASURE”, then press the  key.

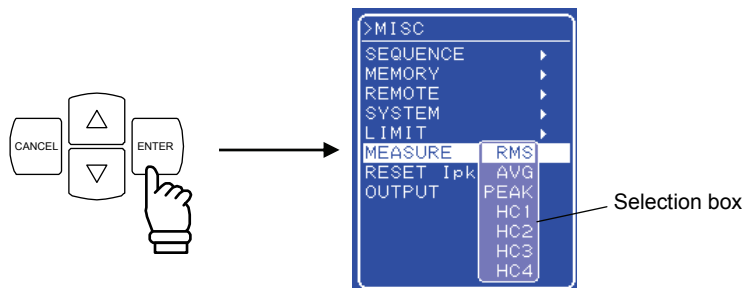
⇒ The selection box is displayed.



3. Press the  or  key to move the cursor to “PEAK”, then press the  key.

⇒ This sets the measurement display to the peak value (PEAK).

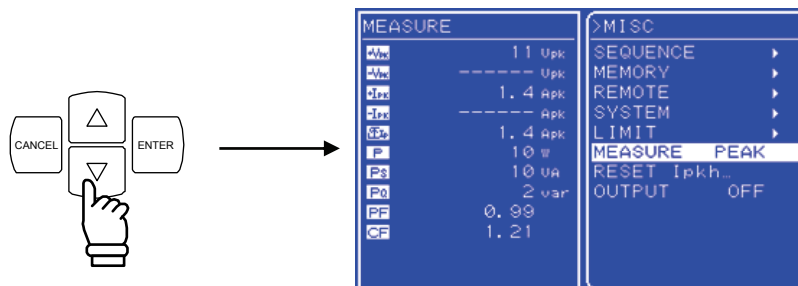

4. Press the TOP MENU key or the CANCEL key to return to the SET menu screen.
 ⇒ The measured value window shows the peak value set in the measurement display.

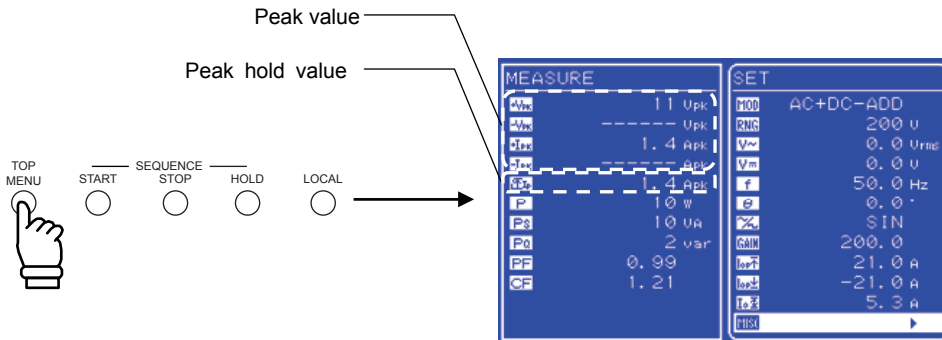

4.2.4 Reset the peak current hold value

The APS-1102 includes a function that resets the peak current hold value. A reset sets the peak current hold value to 0 Apk, and the maximum peak value of current is updated until the next reset is performed. The current peak value is reset automatically at power-on.



To reset the peak current hold value, select “MEASURE” in the MISC menu **MISC**.

■ Operation steps

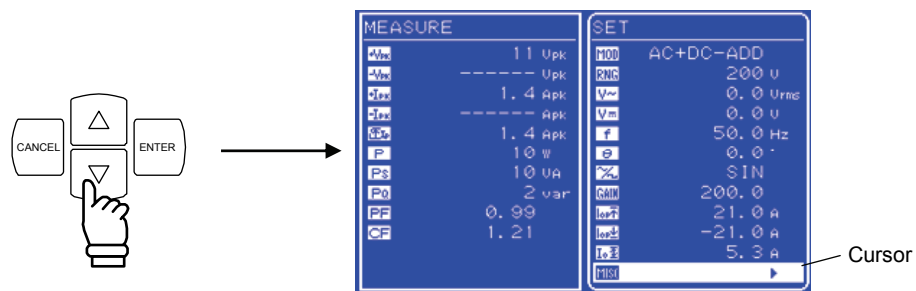
1. Press the or key to move the cursor to the **MISC** icon, then press the key.



⇒ The MISC menu is displayed.

- Press the  or  key to move the cursor to “RESET Ipkh...”, then press the  key.
 ⇒ The EXEC box is displayed.

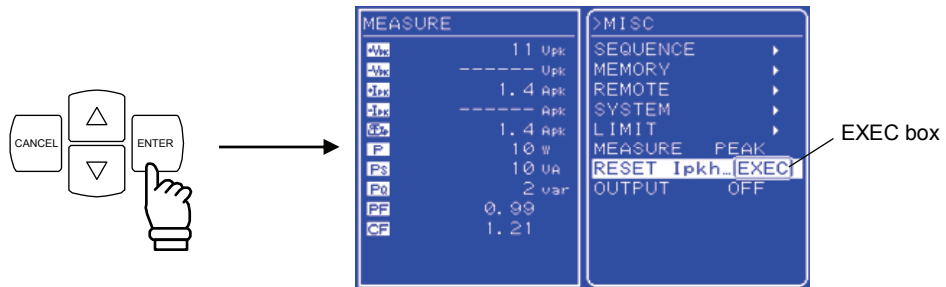

- When “EXEC” is displayed, press the  key.
 ⇒ The peak current hold value is reset.

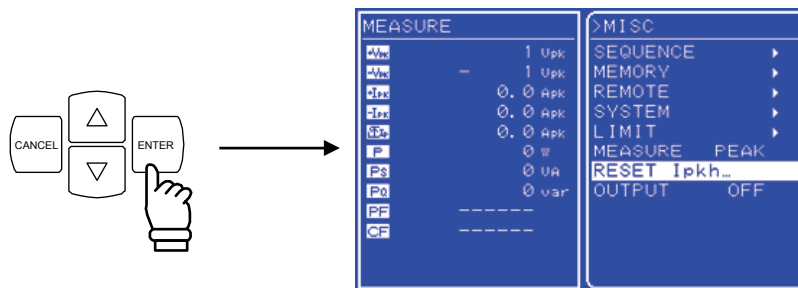

- Press the TOP MENU key or CANCEL key to return to the SET menu screen.
 ⇒ The peak current hold value shown in measured value window becomes 0 Apk.

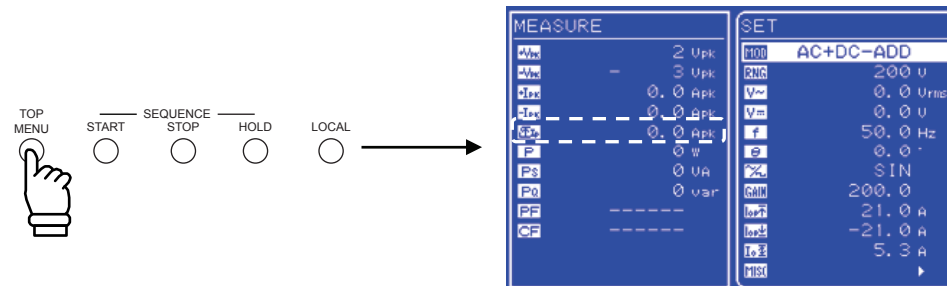

4.3 Measurement of Harmonic Current

Switching power sources are widely used in both consumer and industrial electrical products. The capacitor input type rectifier circuits that are used with such input power lines have disadvantages such as significant distortion of input current and a large amount of harmonic current. When a large amount of this current flows in the power source line, the equipment may experience operation faults, such as voltage distortion, which can cause the transformer to overheat, possibly resulting in a hazardous accident.





The APS-1102 includes a function for measuring harmonic current. This measurement does not comply with the IEC standards.

This measurement can be performed only in AC-INT mode and when the fundamental wave (panel frequency setting) is either 50 Hz or 60 Hz. Absolute values of harmonic current in RMS and their percentages to the fundamental are displayed up to the 40th harmonics (2 kHz at 50 Hz fundamental). When harmonic current measurement is selected, RMS value, average DC, and peak value measurements are not performed. If RMS value, average DC, or peak value has been set, harmonic current measurement is not performed.

a) Changing to harmonic measurement window



To view the harmonic measurement window, select “MEASURE” in the MISC menu .

■ Operation steps

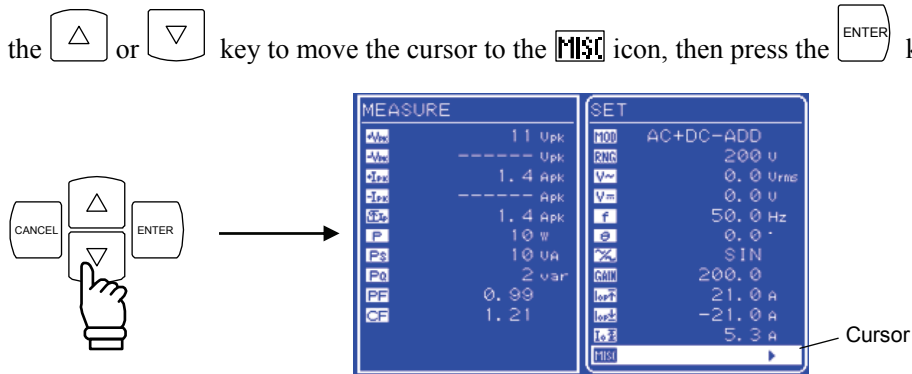
1. Press the  or  key to move the cursor to the  icon, then press the  key.





⇒ The MISC menu is displayed.

2. Press the  or  key to move the cursor to “MEASURE”, then press the  key.

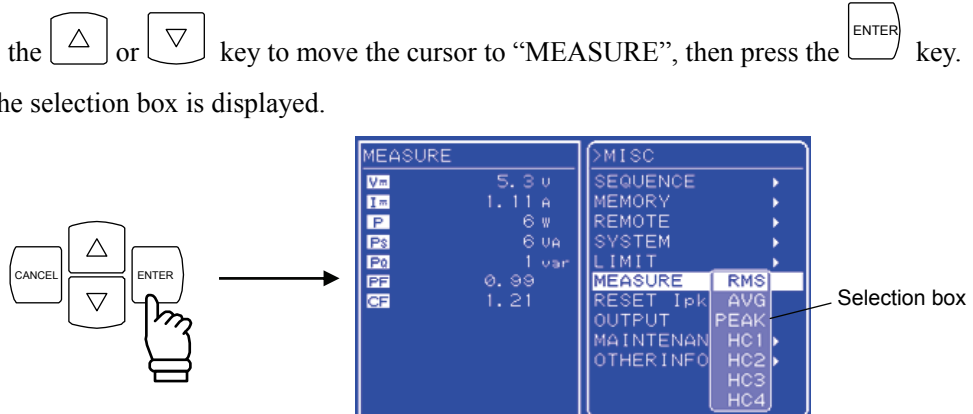
⇒ The selection box is displayed.



- Press the  or  key to move the cursor to the harmonic order to be displayed, then press the  key.

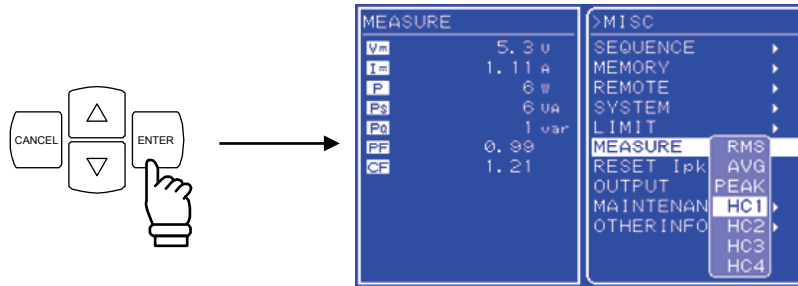

⇒ When HC1 to HC4 have been selected as the displayed measurements, the following harmonic current measured values are displayed.

The displayed harmonic order (XXth) changes according to these ranges, and 10 lines of measurement data are displayed in each range.

- HC1: 1st to 10th
- HC2: 11th to 20th
- HC3: 21st to 30th
- HC4: 31st to 40th

The displayed harmonic order (XXth) changes according to these ranges, and 10 lines of measurement data are displayed in each range.

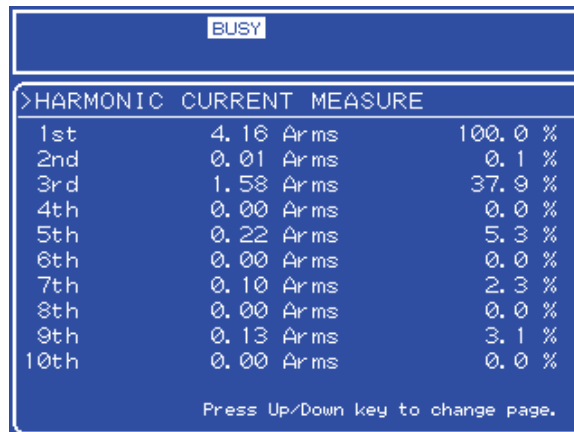





Figure 4-4. Example of Harmonic Measurement Window Display

- Press the  or  key to switch the HC1, HC2, HC3, and HC4 screens.
- Press the  key to end harmonic measurement and return to the TOP MENU (normal display).

4.4 Using the Sequence Function

4.4.1 Sequence operations

When the sequence function of the APS-1102 is used, the pattern to be output can be freely programmed. For example, if a series of voltage change patterns that will be used in voltage variation tests for car electronics are programmed in advance, the output will change according to the sequence, so the test can be completed in one series of operations.

In the sequence operation programming, DC, sine waves, and square waves, which are built in the APS-1102, and arbitrary waveform (16 types) captured via the USB interface are able to use. Maximum step number is 255. In each step, waveform, level, and duration time can be set and constant/keep/sweep can be chosen. In addition, sequences can be repeated from 1 to 999 times (or continuously). The APS-1102 is also equipped with other functions, such as for branching to a specified step during a sequence operation, and for starting, stopping, or holding a sequence operation.

Data is saved to sequence memory automatically.

These sequence functions can be used in AC-INT mode or AC+DC-INT mode.

No. of sequences:	Retained for each operation mode (AC/AC+DC) and each output voltage range (100 V/200 V).	
No. of steps:	1 to 255 (per sequence)	
Step time:	0.1 ms to 999.9999 s (resolution 0.1 ms or 0.0001 s)	
Operations within step:	Constant, keep, or linear sweep	
Parameter:	DC voltage ^{Note} , AC voltage ^{Note} , frequency, waveform, phase (start, end), step synchronized output (2 bits)	
Jump times:	1 to 999 or continuous	
Sequence control:	Start:	Starts a sequence.
	Stop:	Stops a sequence.
	Hold:	Maintains current settings. This is restarted when a sequence is started.
	Branch:	Branches to the specified step.

Note The setting ranges for AC voltage and DC voltage are determined by the output voltage ranges set when editing the sequence data.

Sequence control cannot be executed when output is off.

a) Sequence

A sequence is comprised of a combination of at least two steps (the minimum unit is one step).

b) Step

Step execution parameters and step transition parameters are specified for each step. When sequence execution is not performed (i.e., during normal output mode), these parameters are specified in the same way. Thereafter, the normal output mode is called normal output step. In the descriptions below, the step parameters are enclosed in brackets ([]).

The step execution parameters specify the output and related actions in each step.

Table 4-4. Step Execution Parameters

[Output parameters]	<ul style="list-style-type: none"> • DC voltage • AC voltage • Frequency • Waveform (SIN/SQU/ARB1 to ARB16) • Phase (start phase) • Step synchronized output
[Step operation types]	<p>The following parameters are provided to specify actions related to output at each step.</p> <ul style="list-style-type: none"> • Constant (CONST: Values specified by output parameters are output.) • Sweep (SWEEP: A linear sweep is performed from the previous step end value to the value specified by the output parameter, using the specified step time.) • Keep (KEEP^{Note}: The previous step end value is output.)

Note When the [step operation type] is KEEP, the [output parameter] setting is ignored.

The step transition parameters specify the next step and its timing.

Table 4-5. Step Transition Parameters

[Step time]	Specified in time
[Step end phase]	Sets step end phase as enabled or disabled.
[Step end]	The following parameters are provided to specify the action at the end of the step. <ul style="list-style-type: none"> • Continue sequence (CONT) • Hold (HOLD) • Idle (STOP)
[Jump step]	The following parameters are provided to specify the destination step when a jump occurs after ending the current step. <ul style="list-style-type: none"> • Jump to an arbitrary number step (1 to 255) • Jump to the next number step (0)
[Jump times]	The following parameters set a loop for jumping to the step specified by [jump step] the specified number of times. The following parameters are provided to specify the jump times. <ul style="list-style-type: none"> • Specified number (1 to 999) • Unlimited (0)
[Branch step]	The following parameters are provided to specify the destination step for branch control. <ul style="list-style-type: none"> • Change to arbitrary step number (1 to 255) • Continue step processing without changing (0)

When start is commanded during normal output while in idle mode, step 1 is executed, then the step jumps according to the specified sequence.

If the [jump step] has not been specified (= 0), the step jumps according to the sequence of step numbers, but when the [jump step] has been specified, the step jumps to the step specified by that parameter.

A step ends when the time specified by the [step time] has elapsed. If the [step end phase] has been specified as enabled, the step ends when the [step end phase] value becomes (0°) after the [step time] has elapsed.

If both [step end] and [jump step] have been specified, the [step end] specification takes priority.

An example of basic step transitions is shown below.

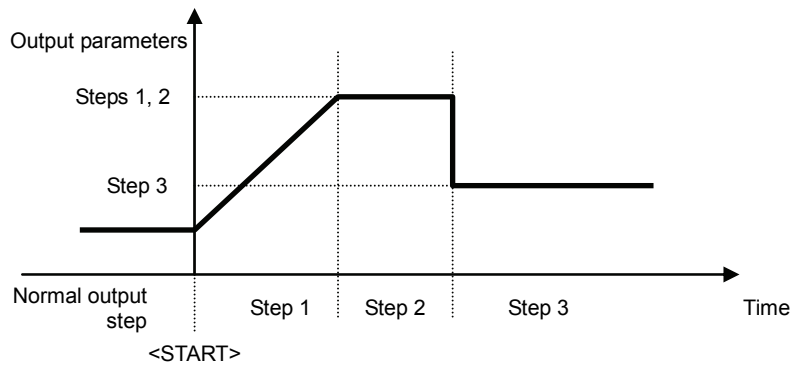

Figure 4-5. Example of Basic Step Transitions

c) Sequence mode

Figure 4-6 shows a mode transition diagram for sequence operations.

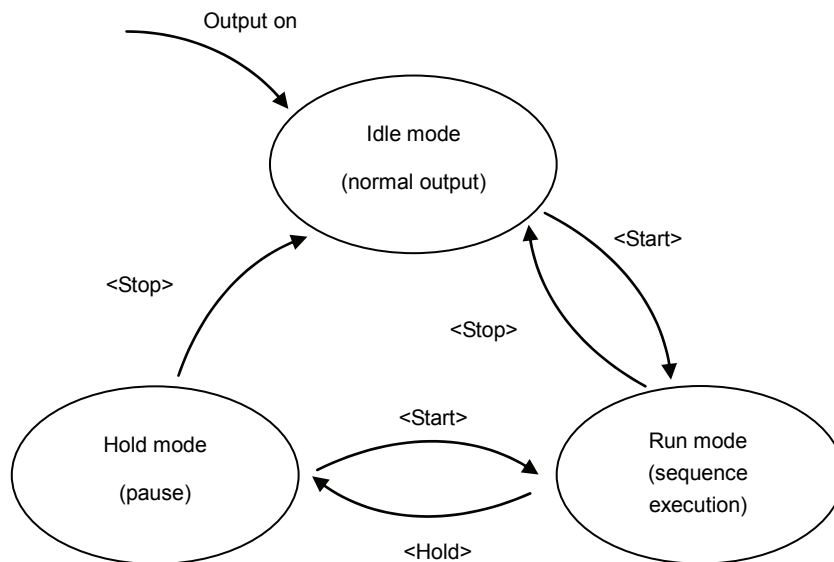

Figure 4-6. Block Diagram of Sequence Mode Transitions

⚠ CAUTION

Modes also change according to the [step end] specification.

Table 4-6. Sequence Modes

Idle mode	Mode during normal output.
Run mode	Mode during sequence execution.
Hold mode	Sequence pause mode. Maintains output at time when <Hold> was set.

d) Sequence control

The following describes how sequence operations are controlled. Sequence control operations are indicated in triangular brackets (< >).

Table 4-7. Sequence Control

<Start>	Sets Run mode. When changing from Idle mode, the operation goes to step 1 when <Start> is set, and the sequence is started. When changing from Hold mode, the sequence is resumed from where it was stopped when <Hold> was set. When <Hold> mode is set by the [step end] parameter, the sequence is resumed at the step specified by [jump step] when <Start> is set.
<Hold>	Changes from Run mode to Hold mode.
<Stop>	Changes to Idle mode. Immediately changes to normal output step. At that time, the values when <Stop> occurred are retained to the normal output step [output parameter]. If the voltage or frequency setting when the <Stop> occur exceeds the setting range limit, it is set to the lower limit value of the setting range limit.
<Branch>	Changes to the step specified by [branch step]. Changes from the output at the time when <Branch> occurred to the [branch step].

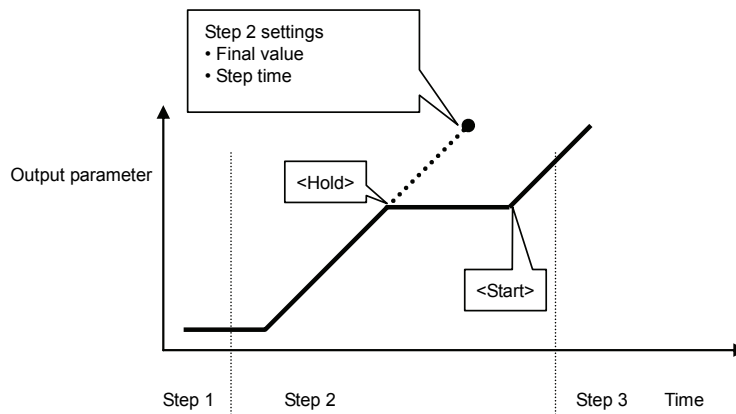

Figure 4-7. Example of Sequence Operation from Hold Mode to <Start>

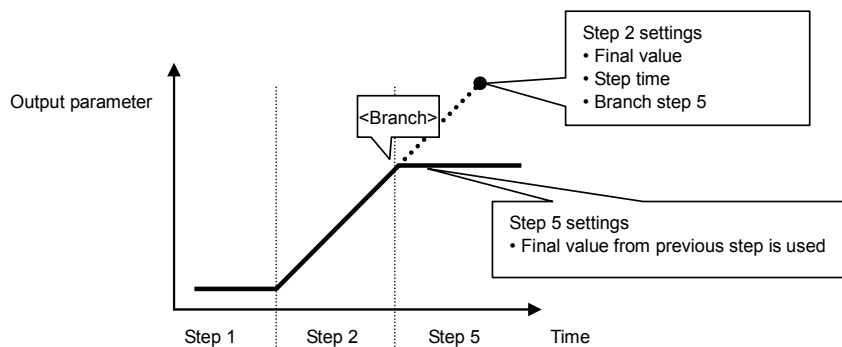

Figure 4-8. Example of Sequence Operation at <Branch>

e) Sequence loop

Either an entire sequence or a block of any number of steps within a sequence can be used as a sequence loop. The loop is implemented based on the [jump step] and [jump times] parameters specified for each step. The jump counter, which counts the number of jumps, functions within each step to retain a count, so multiple loops can be implemented.

Figure 4-9 below illustrates the loop specification method and the step transitions.

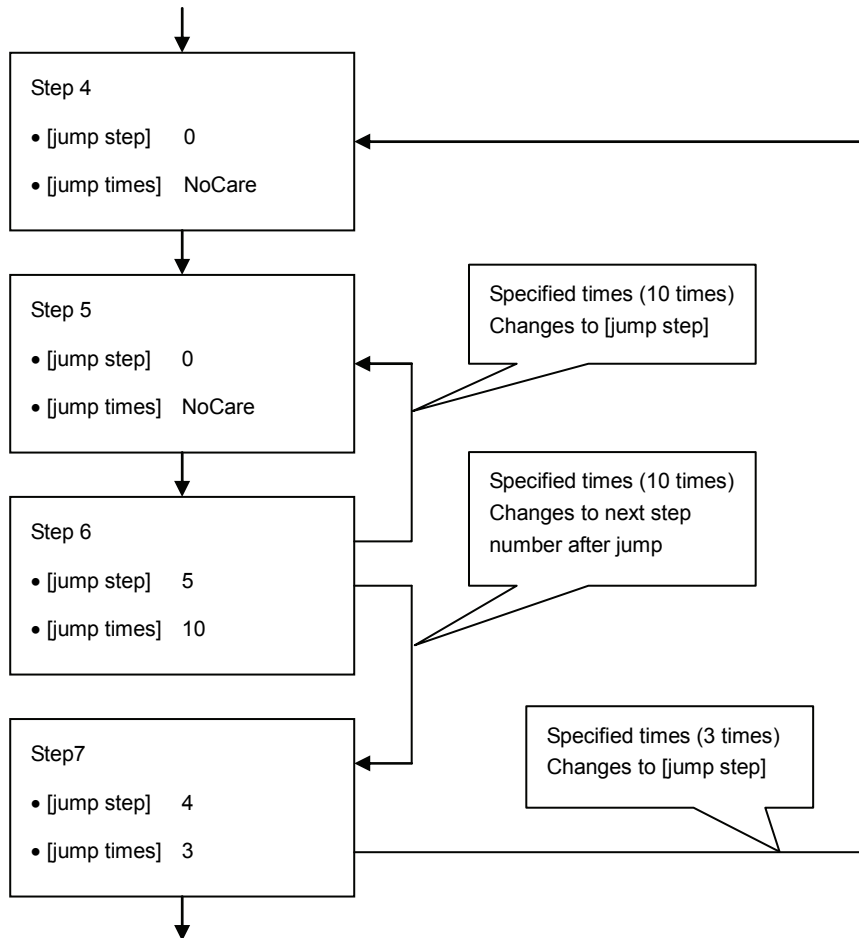

Figure 4-9. Loop Specification Method and Step Transition Example

⚠ CAUTION

[jump times] indicates the number of jumps. Consequently, loop times = jump times + 1. In the example above, 10 jump times are specified for Step 6, so when Step 5 and Step 6 are executed, the number of times = 11.

f) Step synchronized output

The code that is specified in the step being executed is output to the external control I/O connector. However, “0” is output during a normal output step.

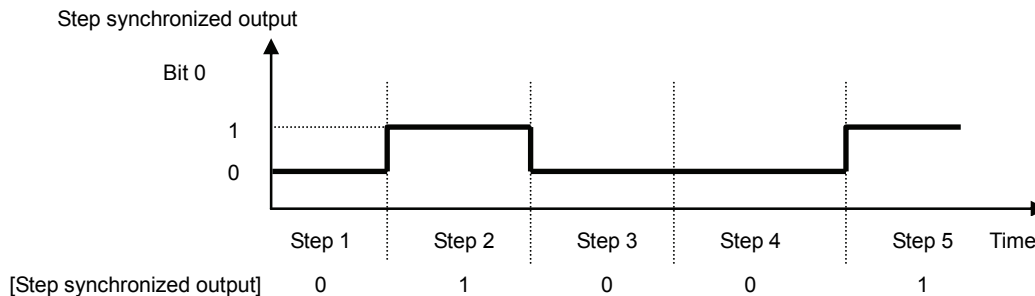

Figure 4-10. Example of Step Synchronized Output

g) Step end phase setting

When the step end phase is set as enabled, the step execution time is as described below.

The step execution time = Set step time + Time for superimposed AC phase to become 0°

After the set step time elapses, the setting for that step is retained in the subsequent operation.

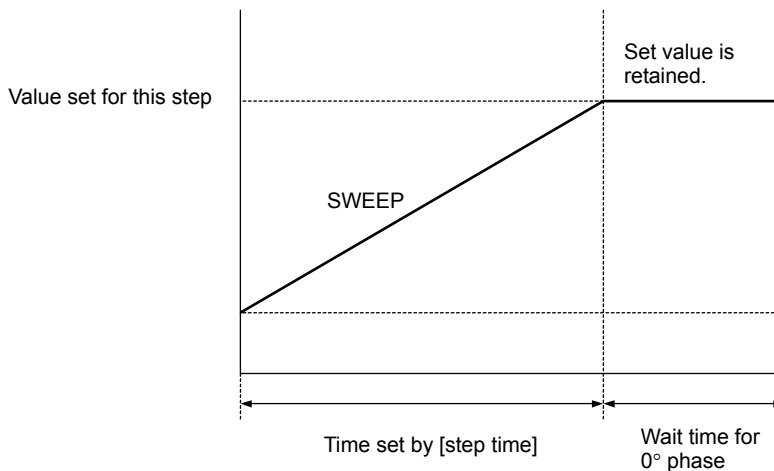

Figure 4-11. Sequence Operation during Wait for Phase 0°

4.4.2 Sequence settings

Sequence settings are made as described below.

- Input per step via control panel
- Programmed from PC, with USB transfer to APS-1102
- Sequence data is edited and transferred using accompanying control software



☞ See “4.4.3 Programming sequences” below, for further description of the program messages for sequence operations.

☞ See the control software user’s manual, for description of the control software.

The operations on the control panel are described below.



■ Operation steps

To display the sequence menu, select “SEQUENCE” in the MISC menu .

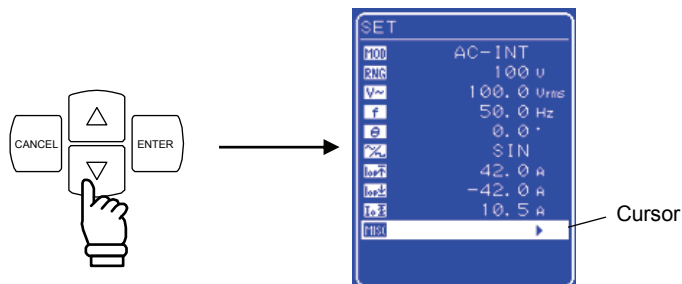
1. Press the  or  key to move the cursor to the  icon.



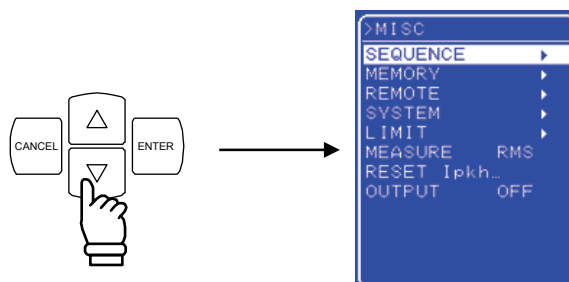

2. Press the  key to display the MISC menu.

Press the  or  key to move the cursor to “SEQUENCE”.

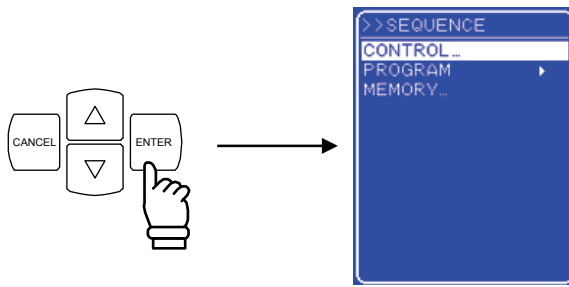

3. Press the  key to display the SEQUENCE screen.



4. Press the  or  key to select the operation to be performed.

- To control sequence operations: select “CONTROL...”.
( See “4.4.4 Control of sequence operations”.)

Note This cannot be selected when output is off.

- To program a sequence: Select “PROGRAM”.
( See “4.4.3 Programming sequences”.)

- To control sequence memory: Select “MEMORY...”.
( See “4.4.5 Clear sequence memory”.)

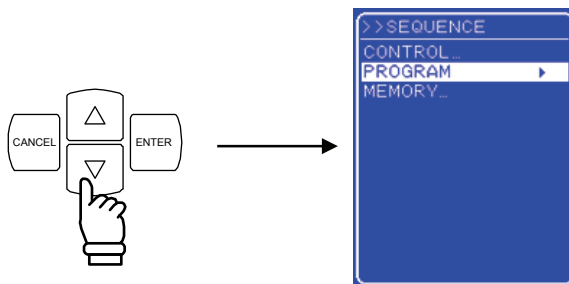

5. Press the  key to display the desired screen .

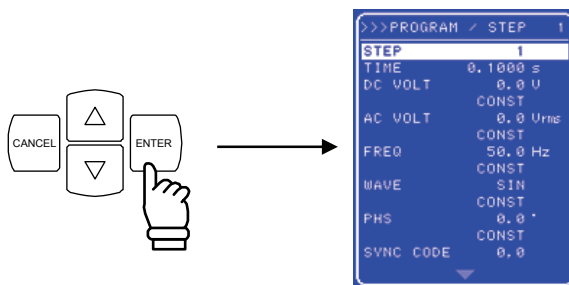

4.4.3 Programming sequences

When “PROGRAM” is selected in the SEQUENCE screen, the PROGRAM screen is displayed. The sequence is programmed according to the various settings in the PROGRAM screen.

To change to the SEQUENCE screen, the output mode must first be switched to AC-INT or AC+DC-INT. Enter step settings per step.

Table 4-8 to Table 4-10 list the setting items in the PROGRAM screen.

Table 4-8. Setting Items in PROGRAM Screen (1/3)

Setting Name	Item	Operation
STEP	Step number	Specifies the step number to be set. Setting range: 1 to 255
TIME	Step time	Specifies the continuation time for the specified step. Setting range: 0.0001 s to 999.9999 s Setting resolution: 0.0001 s (= 0.1 ms) * The time unit can be switched between “s” and “ms” via the SYSTEM menu “TIME UNIT” setting.  See “5.6.5 Time unit setting”.
DC VOLT (AC+DC-INT only)	DC voltage value	Sets the DC voltage value for AC+DC mode. The setting range is determined by the range setting used when editing sequence data. Setting range: 100 V range: -200.0 V to +200.0 V 200 V range: -400.0 V to +400.0 V Setting resolution: 0.1 V
	DC operation type	Sets the method used to change to the specified DC voltage value. Select one of the following three options. <ul style="list-style-type: none"> • CONST: Output specified value • KEEP: Output value at end of previous step • SWEEP: Start by outputting value at end of previous step, then perform a linear sweep to output the specified value at the end of the current step
AC VOLT	AC voltage value	Sets the AC voltage value. The setting range is determined by the range setting entered when editing the sequence data. Setting range: 100 V range: 0.0 Vrms to 140.0 Vrms 0.0 Vp-p to 400.0 Vp-p 200 V range: 0.0 Vrms to 280.0 Vrms 0.0 V p-p to 800.0 Vp-p Setting resolution: 0.1 Vrms/0.1 Vp-p * The voltage value can be set as “Vp-p” only when arbitrary waveform has been selected.
	AC operation type	Sets the method used to change to the specified AC voltage value. Select one of the following three options. <ul style="list-style-type: none"> • CONST: Output specified value • KEEP: Output value at end of previous step • SWEEP: Start by outputting value at end of previous step, then perform a linear sweep to output the specified value at the end of the current step

Table 4-9. Setting Items in PROGRAM Screen (2/3)

Setting Name	Item	Operation
FREQ	AC frequency	Sets the AC frequency. Setting range: 1.0 Hz to 550.0 Hz Setting resolution: 0.1 Hz
	AC frequency operation type	Sets the method used to change to the specified frequency. Select one of the following three options. <ul style="list-style-type: none"> • CONST: Output specified value • KEEP: Output value at end of previous step • SWEEP: Start by outputting value at end of previous step, then perform a linear sweep to output the specified value at the end of the current step
WAVE	Waveform	Selects arbitrary waveform to be output. Setting range: SIN/SQU/ARB1 to ARB16
	Waveform operation type	Sets the method used to change to the specified waveform. Select one of the following two options. <ul style="list-style-type: none"> • CONST: Output specified waveform • KEEP: Output previous step waveform
PHS	Phase	Sets output initial phase. Setting range: 0.0° to 359.9° Setting resolution: 0.1°
	Phase operation type	Sets the method used to change to the specified phase. Select one of the following two options. <ul style="list-style-type: none"> • CONST: Output specified phase • KEEP: Output last step phase
SYNC CODE	Step synchronized output	This sets the code (2 bits) to be output in sync with step execution. The sequence step transitions can be checked by monitoring the step synchronized output. Bit 0 is output from pin 5 (DOUT5) of the external control I/O connector and bit 1 is output from pin 6 (DOUT6). Select one of the following four types of step synchronized output (the numbers are displayed in the order “bit 1, bit 0”). During Idle mode, these values are “0, 0”. <ul style="list-style-type: none"> • 0, 0 • 0, 1 • 1, 0 • 1, 1
	Step synchronized output operation type	Specifies the output method for step synchronized output. Select one of the following two options. <ul style="list-style-type: none"> • CONST: Output specified code • KEEP: Output same code as at previous step
STOP PHS	Step end phase enable/disable	Specifies step end phase as enabled or disabled. Select one of the following two options. <ul style="list-style-type: none"> • DISABLE (phase depends on step time) • ENABLE
	Step end phase	Sets step end phase. Setting range: 0.0° to 359.9° Setting resolution: 0.1°

Table 4-10. Setting Items in PROGRAM Screen (3/3)

Setting Name	Item	Operation
STEP TERM	Step end	Sets operation after end of step. Select one of the following three options. <ul style="list-style-type: none"> • CONT: Sequence continuation • STOP: Change to Idle mode • HOLD: Change to Hold mode
JUMP STEP	Jump step	Sets the step number to jump to after the end of the previous step. <ul style="list-style-type: none"> • 0: Continue to next step number • 1 to 255: Jump to specified step number
JUMP NUM	Jump times	Sets the number of times to execute the jump operation specified by JUMP STEP. <ul style="list-style-type: none"> • 0: Unlimited jumps • 1 to 999: Specified number of jumps
BRANCH0	Branch step 0	Sets the step number to jump to when trigger input has occurred. Two types of branch steps can be set: BRANCH0 and BRANCH1. [Command example]
BRANCH1	Branch step 1	When a STOP is set after a small number of sweeps at the jump destination step, it enables uses where there is a safe region for saving data if necessary. <ul style="list-style-type: none"> • 0: Branch disabled • 1 to 255: Jump to specified step number



The operation steps for each of the setting items in the PROGRAM screen are described below.

■ **Operation step <1>**

The settings for step number (STEP), step time (TIME), DC voltage (DC VOLT, AC+DC mode only), AC voltage (AC VOLT), AC frequency (FREQ), phase (PHS), step end phase (STOP PHS), jump step (JUMP STEP), jump times (JUMP NUM), and branch (BRANCH0/BRANCH1) are made by entering numerical values for various items in the order described below.

The example described below is when entering the setting for step time (TIME).

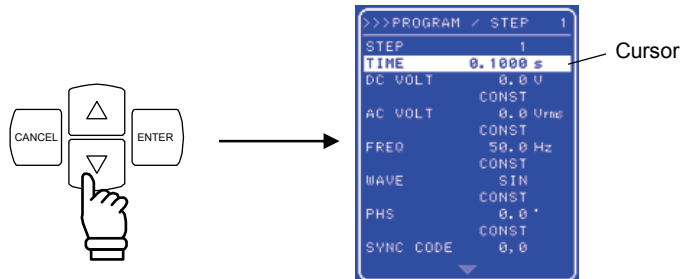

1. Open the SEQUENCE screen and display the PROGRAM screen.
🔗 See “4.4.2 Sequence settings”, for steps for displaying the PROGRAM screen.

2. Press the  or  key to move the cursor to “TIME”.

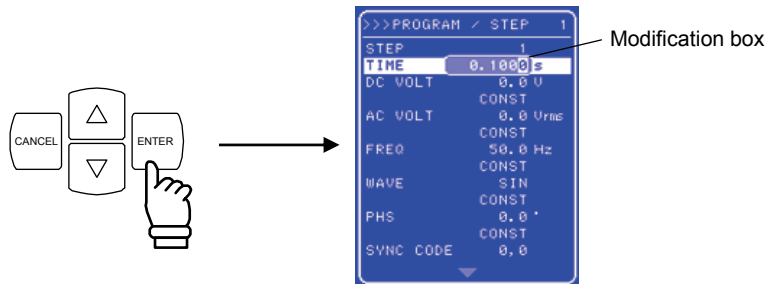

3. Press the  key to display the modification box.



4. Press the  and  keys to move the cursor to the digit to be changed, turn the MODIFY dial and set a numerical value. The set value will be reflected in output immediately.

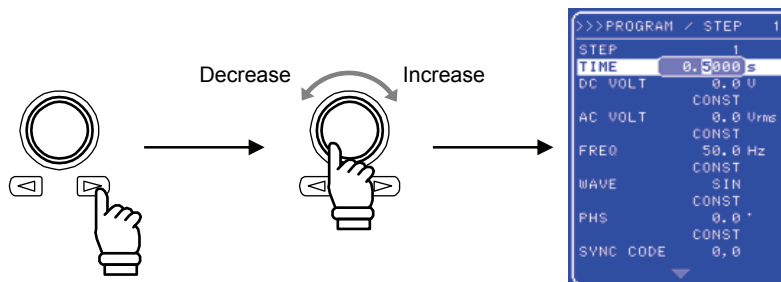

5. Use these steps to set all columns.

6. After setting all of the columns, press the  or  key to close the modification box.



■ **Operation step <2>**

The settings for DC voltage operation type (AC+DC mode only), AC voltage operation type, frequency operation type, waveform (WAVE), waveform operation type, phase operation type, step synchronized output (SYNC CODE), step synchronized output operation type, step end phase enable/disable (STOP PHS), and step end (STEP TERM) are made by selecting settings for the various items in the order described below.

The example described below is when entering the step end (STEP TERM) setting.

1. Open the SEQUENCE screen and display the PROGRAM screen.

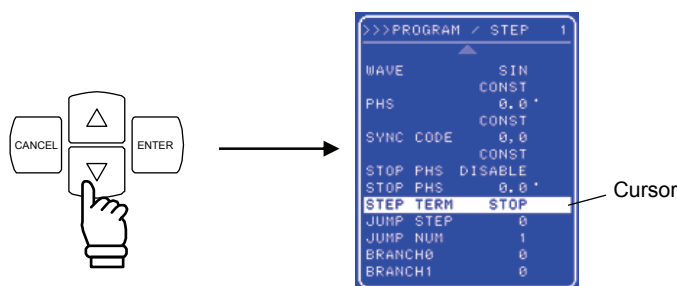

 See “4.4.2 Sequence settings”, for steps for displaying the PROGRAM screen.

2. Press the  or  key to move the cursor to “STEP TERM”.

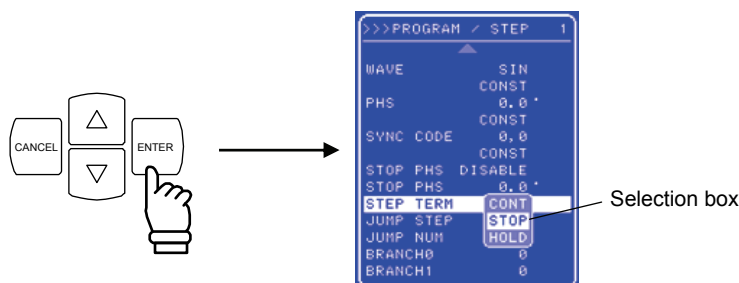

3. Press the  key to display the selection box.



4. Press the  or  key to move the cursor to the operation to be set.

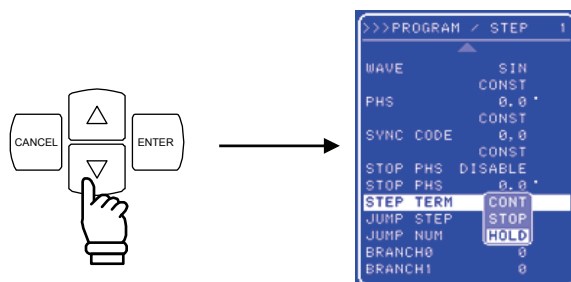

5. Press the  key to set the operation at the step end.

4.4.4 Control of sequence operations

The CONTROL item in the SEQUENCE screen is used to control sequence operations.

A sequence can be started only when output is on. Consequently, the sequence control selection box can be selected only when output is on.

Table 4-11 lists items in the CONTROL selection box.

Table 4-11. Items in CONTROL Selection Box



Selection Box Items	Operation
START	Starts sequence operation. Switches to Run mode.
STOP	Stops sequence operation. Switches to Idle mode.
HOLD	Pauses sequence operation. Switches to Hold mode.
BRAN0	Branches to the step specified by the branch step.
BRAN1	If the branch step is not specified, it is ignored.

The operation steps are described below.

a) When operating from a menu

■ Operation steps

1. When output is on, open the SEQUENCE screen and display the CONTROL selection box.
 See “4.4.2 Sequence settings”, for steps for displaying the CONTROL selection box.

2. Press the  or  key to move the cursor to the operation to be set.

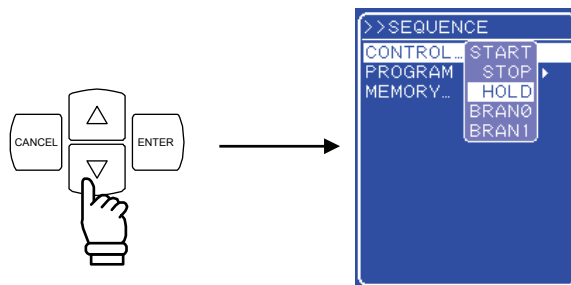

3. Press the  key to perform the selected operation.

b) When operating with the shortcut keys**■ Operation step**

The control of sequence operations, can also be performed with the shortcut keys at the bottom of the control panel.

The START, STOP, and HOLD keys under “SEQUENCE” correspond to items in the CONTROL selection box. Shortcut keys cannot be used to control branching.

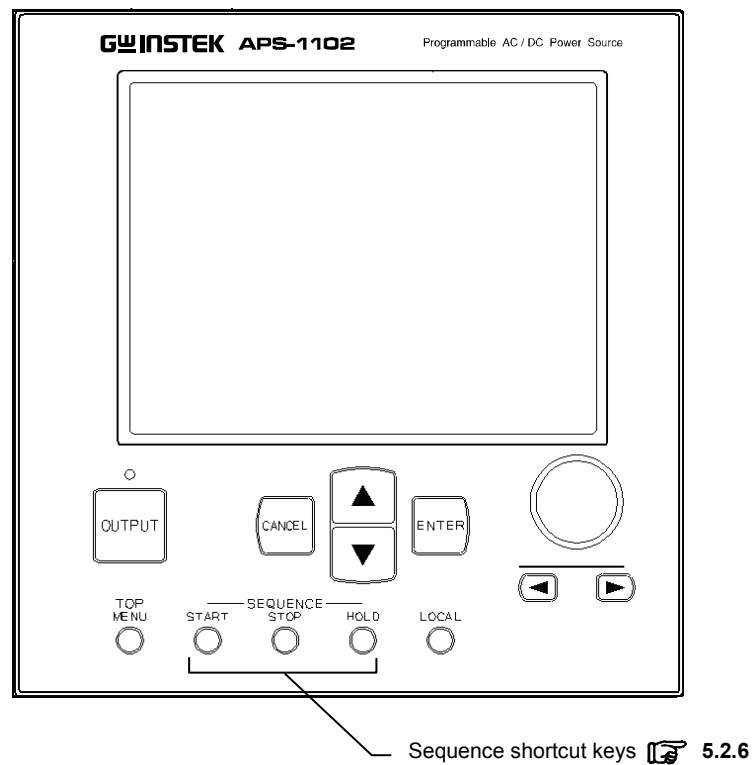

Figure 4-12. Sequence Shortcut Keys

4.4.5 Clear sequence memory

Data is saved to sequence memory automatically. Separate sequence data can be saved for 100 V range and 200 V range in AC-INT mode and for 100 V range and 200 V range in AC+DC-INT mode.

When clearing the sequence memory, use “MEMORY...” in the SEQUENCE screen.

The operation steps are shown below.

■ Operation steps

1. Open the SEQUENCE screen and display the MEMORY EXEC box.

 See “4.4.2 Sequence settings”, for description of the sequence for displaying the MEMORY EXEC box.

2. Press the  key to display the EXEC box .

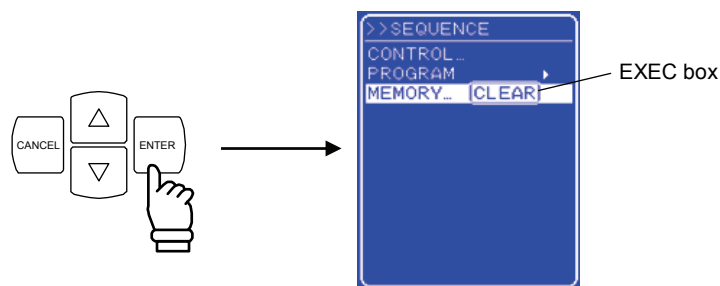

3. After “CLEAR” has been selected, if the  key is pressed, the entire sequence memory is cleared.

During the memory clear operation (which lasts 5 to 6 seconds) key input can be accepted, but the operations set by the key is executed after clearing is completed.

⇒ After clearing, initial values are set. ( See “3.2 Display and Initial Settings at Power-on”.)

4.4.6 Example of sequence operation settings

The following describes the steps for setting a new sequence operation, based on the sequence transition example described in **Table 4-12**. The time unit is seconds (s). (See “5.6.5 Time unit setting” to change the time unit.)

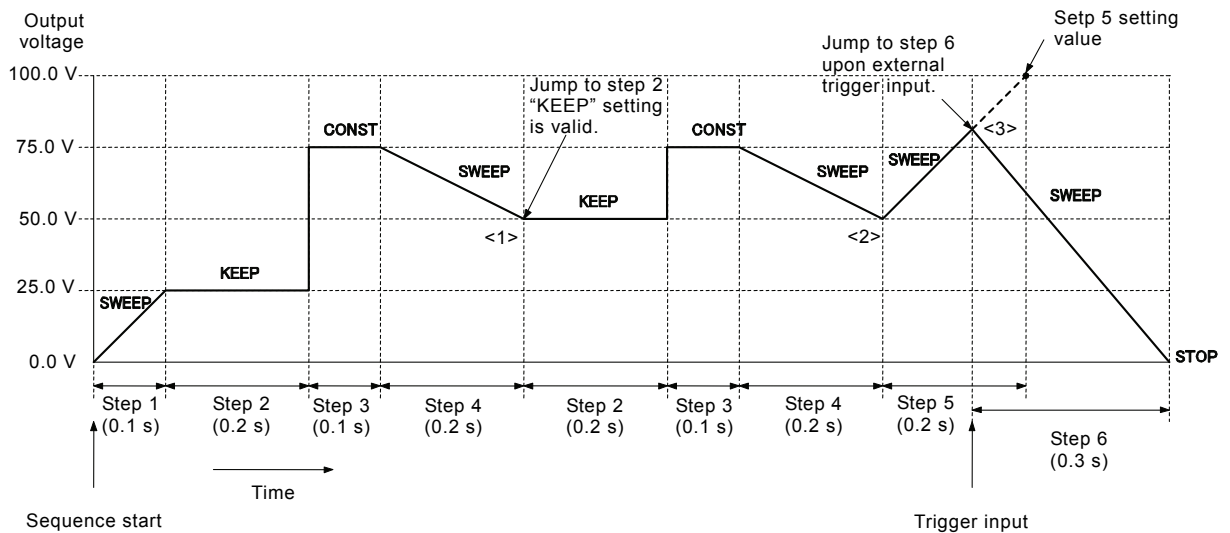

Figure 4-13. Step Transition Example (during AC+DC-INT mode)

Table 4-12. Program Settings

Step Number	1	2	3	4	5	6
Step time (TIME)	0.1	0.2	0.1	0.2	0.2	0.3
DC voltage (DC VOLT)	25.0	25.0	75.0	50.0	100.0	0.0
DC voltage operation type	SWEEP	KEEP	CONST	SWEEP	SWEEP	SWEEP
Step end (STEP TERM)	CONT	CONT	CONT	CONT	CONT	STOP
Jump step (JUMP STEP)	0	0	0	2	0	0
Jump times (JUMP NUM)	1	1	1	1	1	1
Branch 0 (BRANCH0)	0	0	0	0	6	0
Step time (TIME)	0.1	0.2	0.1	0.2	0.2	0.3

Since jump step = 2 has been set at step 4, a jump to step 2 occurs after step 4 is completed (<1> in **Figure 4-13**). At that time, a conflict exists between the step 2 settings, which are for both DC voltage value (25.0 V) and DC voltage operation type (kept at 50.0 V), but since the operation type setting always takes priority, only the DC voltage value = 50.0 V is valid.

Since jump times = 1 has been set, when step 4 is again completed after the jump, control switches to step 5 (<2> in **Figure 4-13**).

At step 5, step time = 0.2 s and DC voltage value = 100.0 have been set, but when trigger input occurs this step control is transferred to step 6 (<3> in **Figure 4-13**).

The operation steps are described below.

■ **Operation steps using control panel**

1. Open the PROGRAM screen.

The steps for opening the PROGRAM screen are described in “4.4.2 Sequence settings”.

- Setting step 1

2. Press the key to move the cursor to “DC VOLT”.

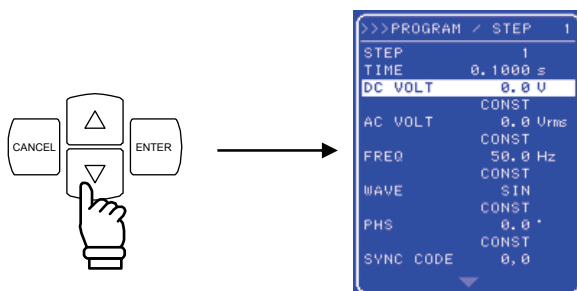

3. Press the key to display the modification box.

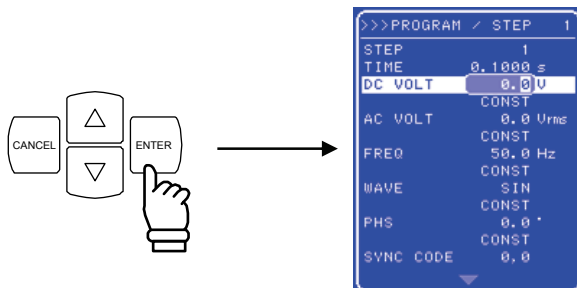

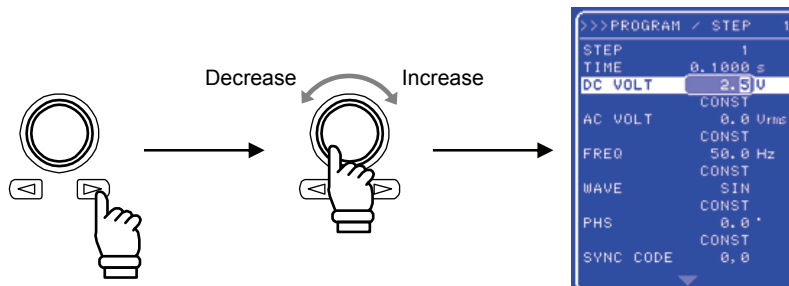

4. Press the and keys to move the cursor to the 10’s place, then turn the MODIFY dial to set “2”. Next, move the cursor to the 1’s place and turn the MODIFY dial to set “5”.
⇒ This sets “25.0 V”.



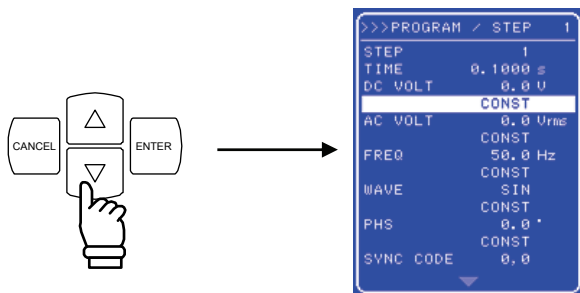

5. Press the or key to close the modification box.

6. Press the  key to move the cursor to the line displaying “CONST” (fourth line from the top).

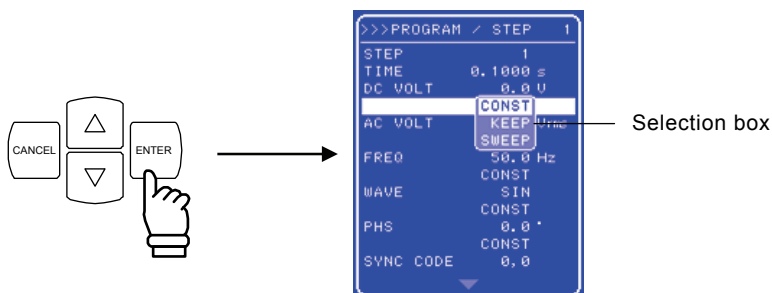

7. Press the  key to display the selection box.



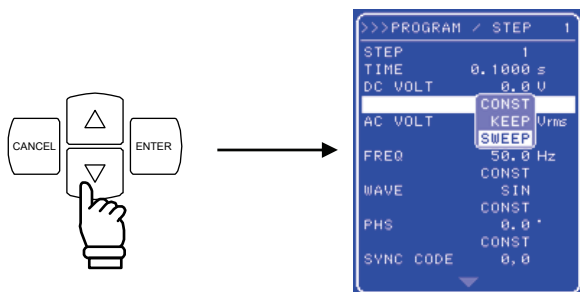

8. Press the  or  key to move the cursor to “SWEEP”.





9. Press the  key to confirm the setting.



The settings for all other items are the same as the default settings, so they are not changed.

- Setting step 2

10. Press the  or  key to move the cursor to “STEP”.



11. Press the  key to display the modification box.



12. Press the  and  keys to move the cursor to 1’s place, then turn the MODIFY dial to set “2”.
The set value will be reflected in output immediately.

13. Press the  or  key to close the modification box.

14. Press the  key to move the cursor to “TIME”.

15. Press the  key to display the modification box.

16. Press the  and  keys to move the cursor to the 0.1’s place, then turn the MODIFY dial to set “2” (this sets “0.2 seconds”). The set value will be reflected in output immediately.

17. Press the  or  key to close the modification box.

18. Using the same operations as in steps 2 to 5, set DC VOLT = 25, and using the same operations as in steps 7 to 9, set the DC voltage operation type as “KEEP”.

Use the same operation steps to set step 3 and subsequent steps.

4.4.7 Execution of sequence operations

Once sequence programming has been completed, start the sequence.
 The execution steps for the sequence operations are described below.

a) When using the MISC menu

■ **Operation steps**

1. Press the TOP MENU key (shortcut key) to return to the top menu. In the top menu, “SET” is shown in the upper left corner of the menu window.

The sequence is executed only when output is on. Make sure output is on beforehand.

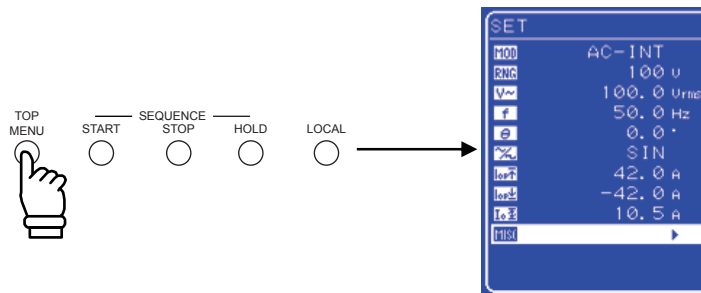

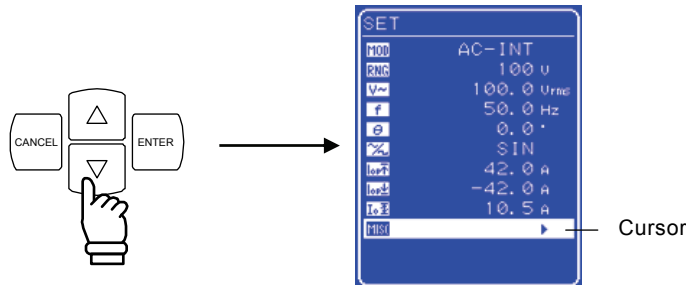

2. Press the or key to move the cursor to the **MISC** icon.



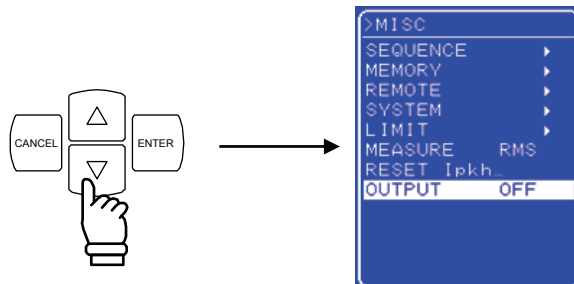

3. Press the key to display the MISC menu

Press the or key to move the cursor to “OUTPUT” .

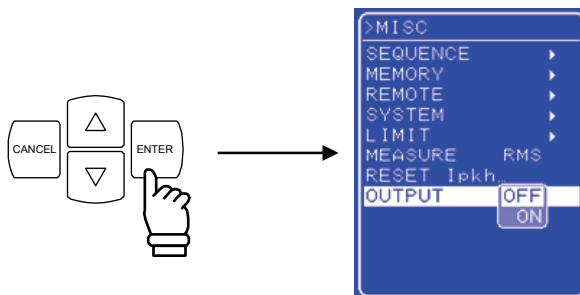

4. Press the  key to display the selection box.



5. Press the  key to move the cursor to “ON”.

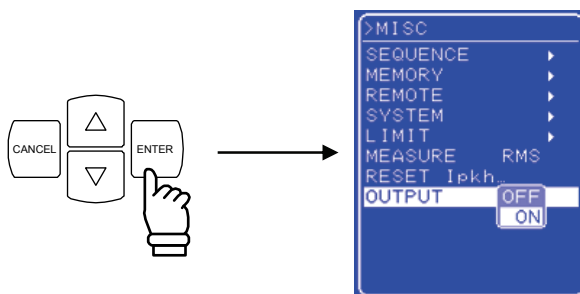

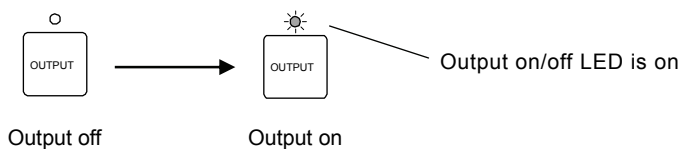

6. Press the  key to set output on, at which time the output on/off LED goes on.

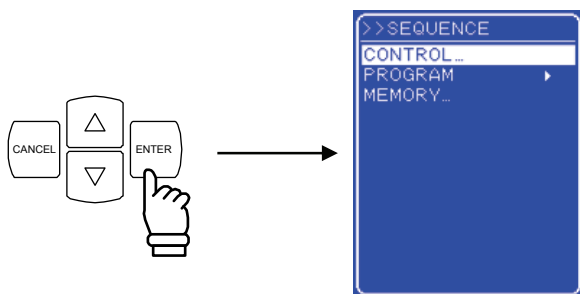

7. Select “SEQUENCE”, then press the  key to display the SEQUENCE screen .



- Press the  key to select “CONTROL”, then press the  key to display the selection box.

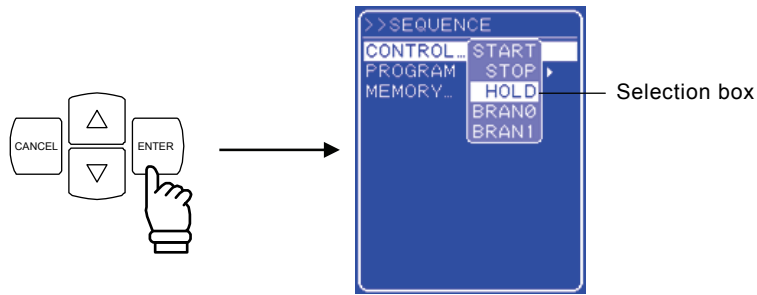

- Select “START”, then press the  key to start the sequence.

b) When using keys on the control panel

■ Operation steps

- Press the TOP MENU key to return to the top menu, check the settings in the menu, then press the  key on the control panel.

⇒ This set output on, at which time the output on/off LED goes on.

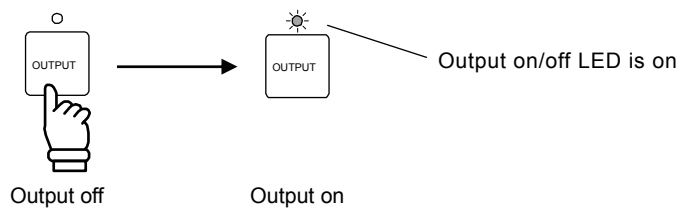

- Press the START key (shortcut key) to start sequence.

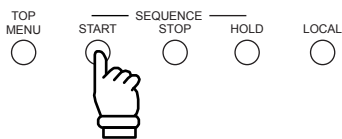

c) Operations after starting sequence

When a sequence is started, the status icon (**RUN**) is displayed in the status window to indicate that the sequence is being executed. A message box is also displayed to indicate the step number being executed.

After returning to the SET screen, if the sequence is executed, the current step settings will not be shown in the SET screen. When the sequence is completed, the settings from the final step will be shown. If the final step voltage and frequency settings are outside of the setting range limit, the setting range limit lower limit value will be shown.

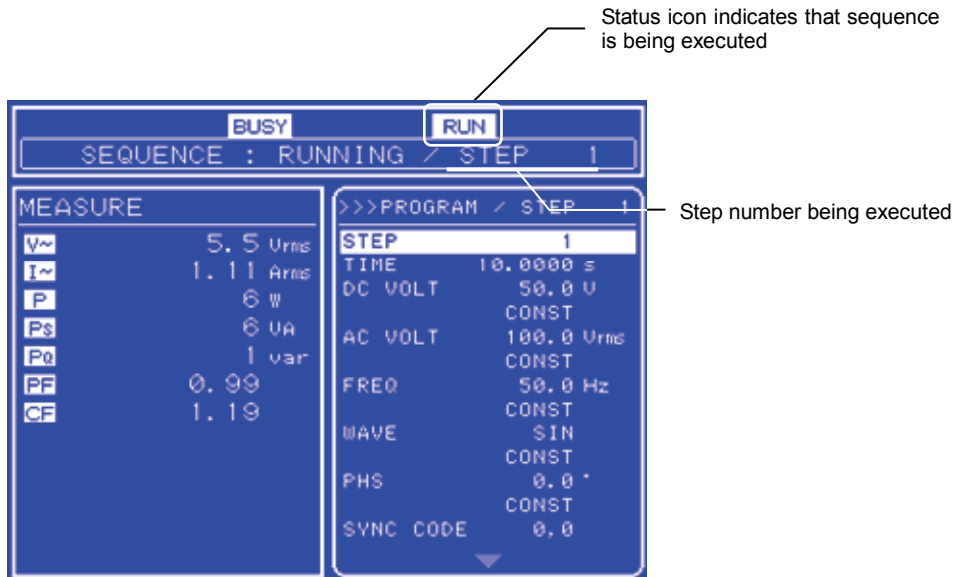

Figure 4-14. LCD Screen During Sequence Execution

4.5 Control Using External Control I/O Connector

Digital signals that are input to the external control I/O connector can be used to control sequences and the output on/off setting. The sequence step synchronized output signals are output from the external control I/O connector.

The status of the APS-1102 can be monitored by reading the output signals from the external control input/output connector.

 See “3.3.4 External signal input/external sync signal input terminal”.

After the external signal input level was changed, approx. 50ms might be required for the controller to execute a function as a maximum response time. “Output ON/OFF” additionally requires the similar time for a response of a relay device.

Table 4-13 lists the functions of the connector various pins.

Table 4-13. Functions of External Control I/O Connector

Pin No.	Input/Output	Function
1	Output	Outputs power source on/off status. 0 = Off, 1 = On.
2	Output	Outputs the output on/off status. 0 = Off, 1 = On.
3	Output	Outputs the limiter operation status. 0 = Not operating, 1 = Operating.
4	Output	Outputs the software busy status. 0 = Normal operation, 1 = Busy.
5	Output	Step synchronized output 0. Outputs bit 0 of step synchronized output.
6	Output	Step synchronized output 1. Outputs bit 1 of step synchronized output.
11	Input	Output off. Sets output off when falling of input signal is detected.
12	Input	Output on. Sets output on when falling of input signal is detected.
13	Input	Start sequence. Starts sequence when falling of input signal is detected.
14	Input	Stop sequence. Stops sequence when falling of input signal is detected.
15	Input	Hold sequence. Holds (pauses) sequence when falling of input signal is detected.
16	Input	Sequence branch trigger 0. Jumps to step specified by BRANCH0 when falling of input signal is detected.
17	Input	Sequence branch trigger 1. Jumps to step specified by BRANCH1 when falling of input signal is detected.

4.6 Output of Arbitrary Waveforms

Arbitrary waveforms are generated by transferring data from an external PC to arbitrary waveform memory via a USB interface.

Arbitrary waveforms can be edited and transferred using the accompanying control software.

 **See the control software user's manual**, for description of this control software.

When output is on, arbitrary waveforms cannot be changed. Make sure that output is off before changing arbitrary waveforms.

a) Arbitrary waveform memory

The APS-1102 includes arbitrary waveform memory as an internal signal source, and this memory can be written to via the USB interface. Arbitrary waveform memory cannot be written to from the panel screen.

- Waveform memory count: 16
- Waveform length: 4096 [words]
- Waveform data: 15-bit binary (2's complement format)

The valid range of waveform data is from -16384 to 16383.

If a value less than -16384 is input, the waveform data is clipped to -16384, and if a value greater than 16383 is input, the waveform data is clipped to 16383.





When the power source is off, arbitrary waveform memory data is retained by battery backup.

At the initial settings (factory settings) and when the memory is cleared, a sine wave is written to ARB1 to ARB8, a square wave to ARB9 to ARB12, and a triangle wave to ARB13 to ARB16.



b) Output of arbitrary waveform

To select an arbitrary waveform, select  in the SET menu.

■ Operation steps

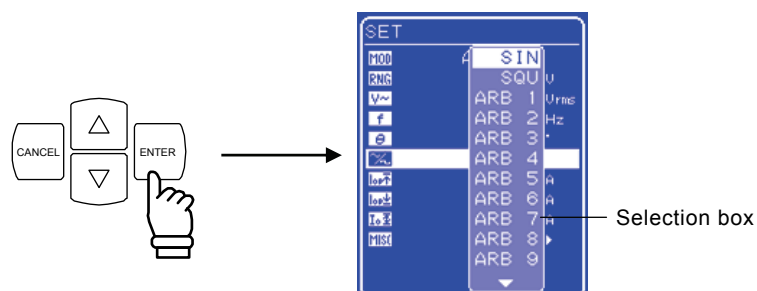
1. Press the  or  key to move the cursor to the  icon, then press the  key to display the selection box.



2. Press the  or  key to move the cursor to the arbitrary waveform to be selected (“ARB1” to “ARB16”), then press the  key.
 ⇒ This sets the selected arbitrary waveform.

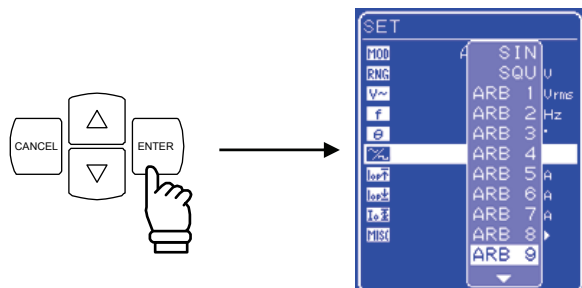

4.7 Synchronization of Output to External Signal

The APS-1102 is equipped with an externally synchronized oscillation function. The software PLL function synchronizes the output frequency to the frequency of the external synchronization TTL signal. The output frequency can be synchronized to any frequency from 40 to 500 Hz. The synchronization phase difference cannot be set.

Select either external signal synchronous (EXT) or line synchronous (LINE) as the external sync signal source.

When line synchronous is selected, synchronization is with the power source frequency.

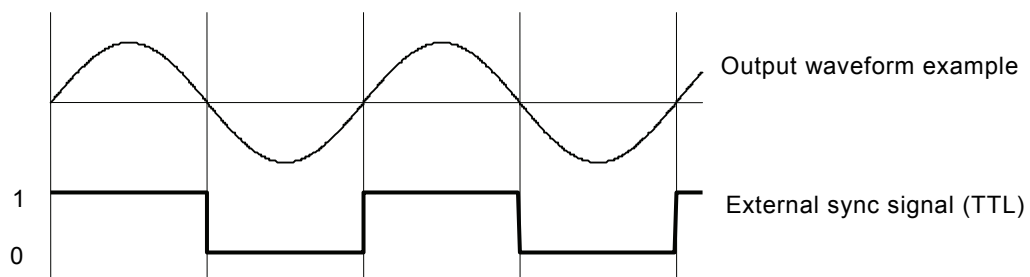

Figure 4-15. Synchronized TTL Signal

4.7.1 External signal synchronization



This function synchronizes the output frequency to a signal that is input to the rear panel external sync signal input (BNC connector). The output frequency can be synchronized to any frequency from 40 to 500 Hz.

■ Operation steps

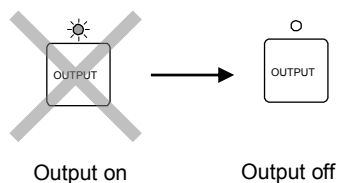

Select **M00** in the SET menu to select external synchronization mode, then set the sync signal source to external sync signal “EXT”.

1. Make sure that output is off. When output on, line synchronization cannot be switched off or on.

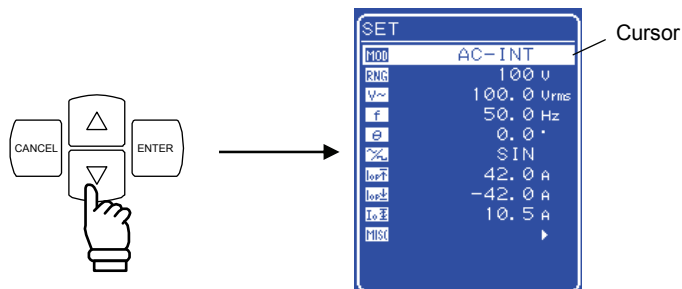

2. Press the  or  key to move the cursor to the **M00** icon.





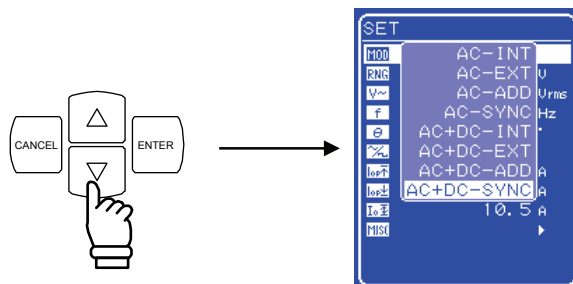

3. Press the  key to display the selection box, then press the  or  key to move the cursor to “AC-SYNC” or “AC+DC-SYNC”.

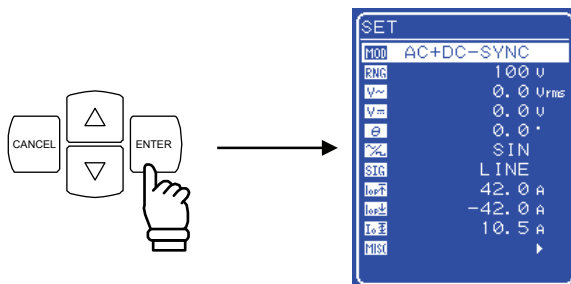



4. Press the  key to select the mode to be set.

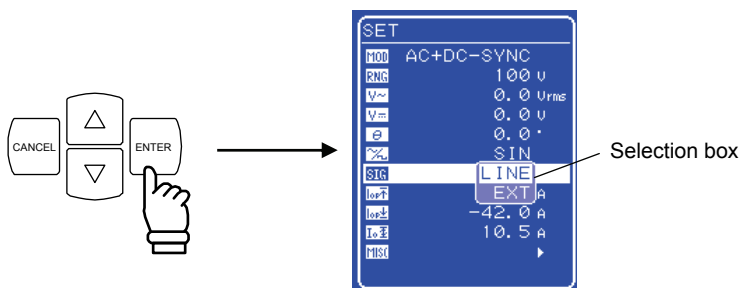

5. Press the  or  key to move the cursor to the  icon, then press the  key to display the selection box.



6. Press the  or  key to move the cursor to “EXT”, then press the  key.
 ⇒ This sets the external sync signal source to external sync signal “EXT”.

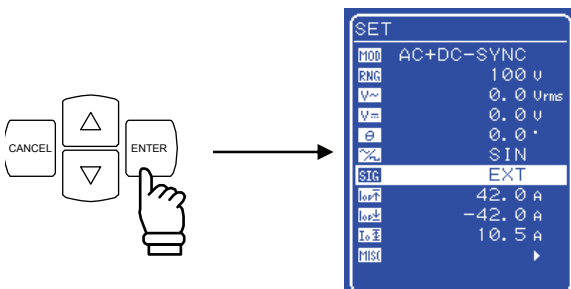

⚠ CAUTION

The frequency range for external synchronization is 40 to 500 Hz. Only use settings within this range.

4.7.2 Line synchronization

This function synchronizes the output frequency to the frequency of the AC power source line. The output frequency can be synchronized to power source line frequency (50 Hz/60 Hz).

■ Operation steps

Select **MOD** in the SET menu to select external synchronization mode, then set the sync signal source to line synchronization (“LINE”).

1. Perform the same operations as were described above for steps 2 to 5 in “4.7.1 External signal synchronization” to select external synchronization mode, after which the external sync signal source selection box will be displayed.

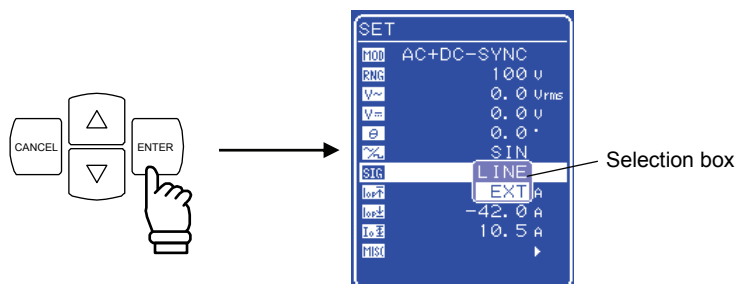

2. Press the or key to move the cursor to “LINE”, then press the key.
⇒ This sets the external sync signal source to “LINE”.

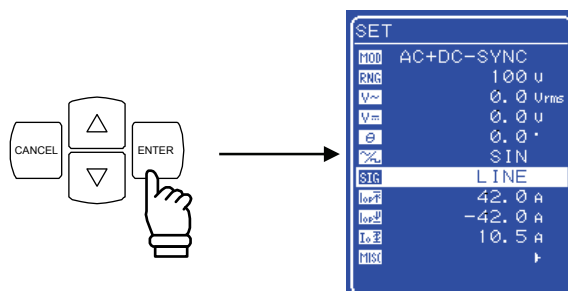

4.8 Using Memory Functions

Various settings are retained in memory with battery backup, and the settings when the power source was last turned off are restored at power-on.

Among these various settings, the basic settings (output mode, output range, DC settings, AC settings, output current limiter, and setting range limit) can be stored in store/recall memory No. 1 to No. 30, and these stored settings can be recalled.

The recall operation for store/recall memory can be executed only when output is off.

Memory control is performed via the “MEMORY” screen. After selecting an operation listed in **Table 4-14**, use the selection box to specify the target memory number.

When a memory number is specified, the main settings stored in that memory are displayed in the left side of the menu window.

Table 4-14. Menu Items in MEMORY Screen

Indication on Control Panel	Type
STORE...	Stores settings to specified memory number.
RECALL...	Recalls settings from specified memory number.
CLEAR...	Clears settings in specified memory number.

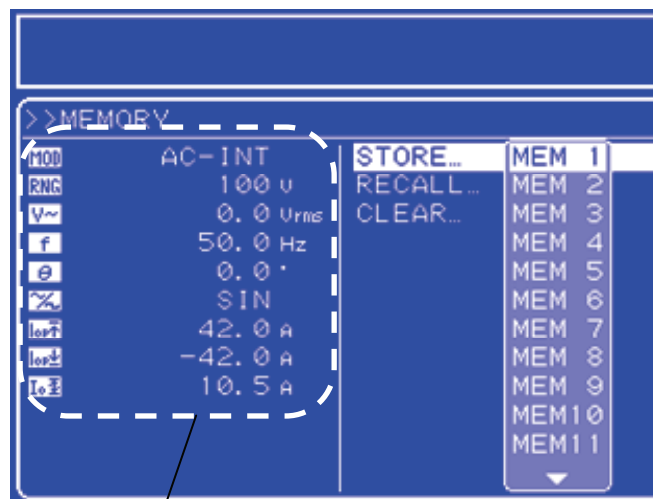



Settings from selected memory are shown here

Figure 4-16. Example of Settings from Memory



■ **Operation steps**

Select **MISC** and then “MEMORY” in the MISC menu to store, recall, or clear memory or to set the target memory number.

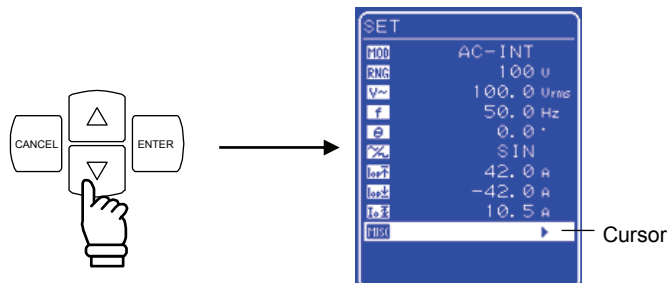
1. Press the  or  key to move the cursor to the **MISC** icon.



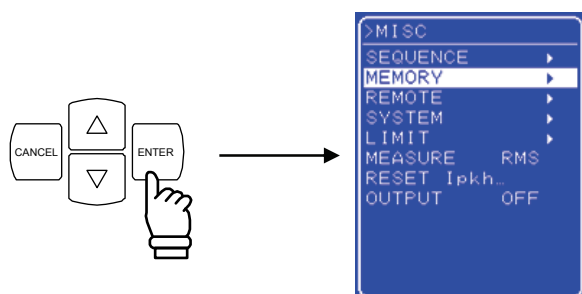

2. Press the  key to display the MISC menu.

Press the  or  key to move the cursor to “MEMORY”.

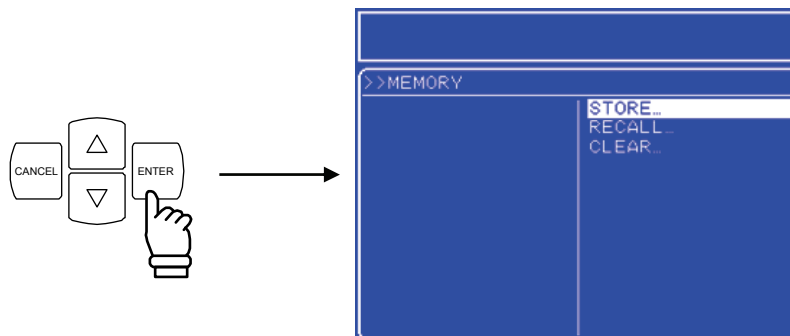

3. Press the  key to display the MEMORY screen.



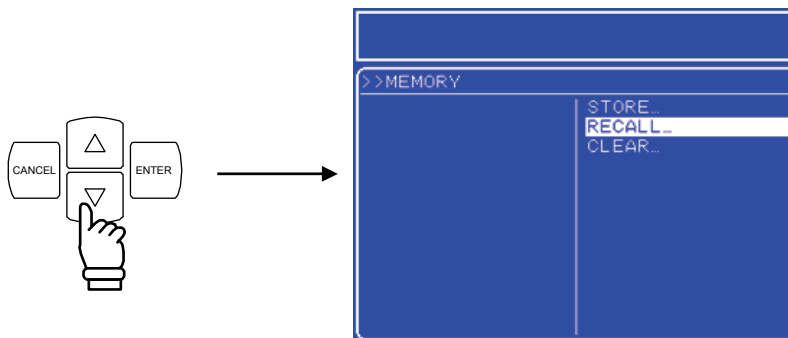

4. Press the  or  key to select the operation to be performed.

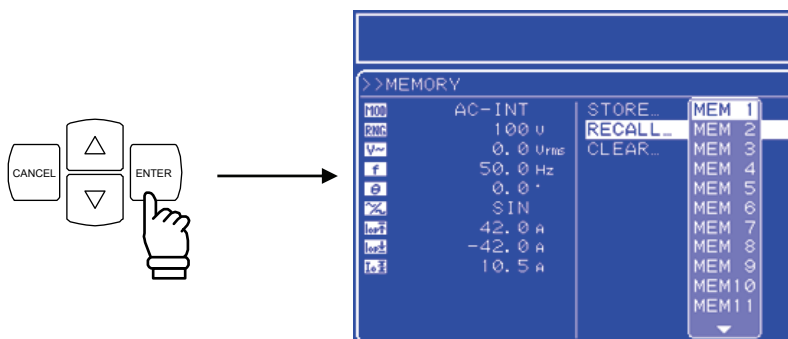

5. Press the  key to display the selection box.



6. Press the  or  key to move the cursor to the target memory number.

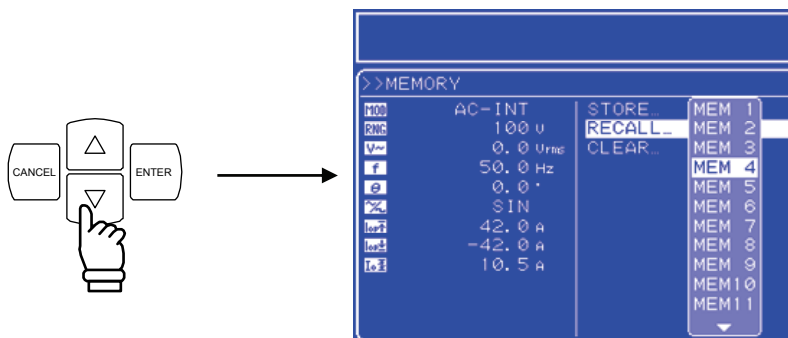

7. Check the settings shown in the left side of the menu window, and if they are OK press the  key.

⇒ This performs the operation specified in step 4 for the specified memory number.

4.9 Amplification of External Signal

The APS-1102 can be used as an amplifier to which a signal is input from the external signal input terminals on the rear panel, by selecting the external signal source mode (AC-EXT or AC+DC-EXT). Connect the external signal source to the external signal input/external sync signal input terminal (EXT SIG IN/EXT SYNC IN) on the rear panel. For this connection, use a coaxial cable with a BNC connector. The input impedance is 10 k Ω (unbalanced) and the input frequency ranges from DC to 550 Hz.

$$\text{Output voltage} = \text{input voltage} \times \text{external input gain}$$

Table 4-15. External Input Gain Setting Range

Setting		Setting Range	Resolution	Initial Value
External input gain	100 V range	0.0 to 200.0	0.1	100.0
	200 V range	0.0 to 400.0	0.1	200.0

For description of the External signal input/external sync signal input terminal specifications:

 See "3.3.4 External signal input/external sync signal input terminal".

CAUTION



Be sure to read this section carefully before entering settings, so as to prevent problems in this product or the load.

a) Possible voltage settings for output



■ Operation steps

Select the icon in the SET menu corresponding to the desired setting, then set a numerical value.

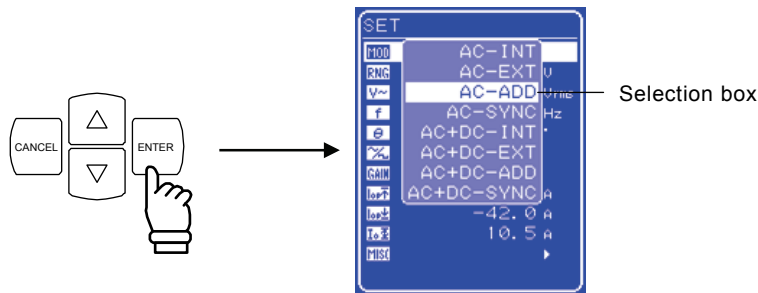

- **MOD** “Select output mode”: Select external mode (AC-EXT or AC+DC-EXT).
- **RNG** “Output voltage range”: Select 100 V or 200 V.
- **GAIN** “Set external input gain”: Set a numerical value.

1. Press the  or  key to move the cursor to the **MOD** icon, then press the  key.
⇒ The selection box is displayed.



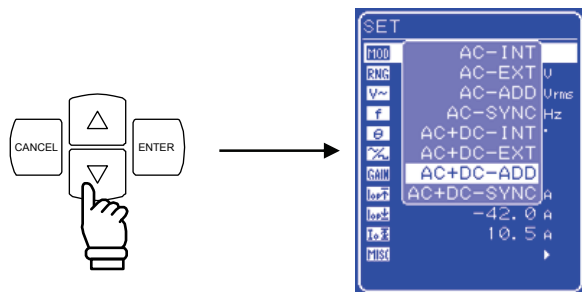

2. Press the  or  key to move the cursor to the mode to be set, then press the  key.
⇒ This sets the selected output mode.

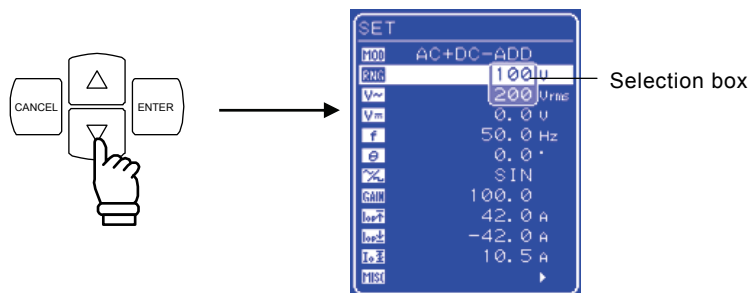

3. Press the  or  key to move the cursor to the **RNG** icon, then press the  key.
⇒ The selection box is displayed.





4. Press the  or  key to move the cursor to the output voltage range to be set, then press

the  key.

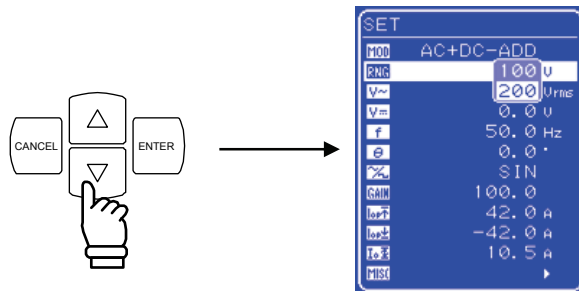

⇒ This sets the selected output voltage range.



5. Press the  or  key to move the cursor to the **GAIN** icon, then press the  key.

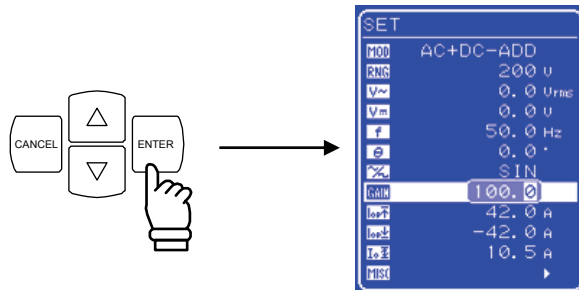

⇒ The modification box is displayed.

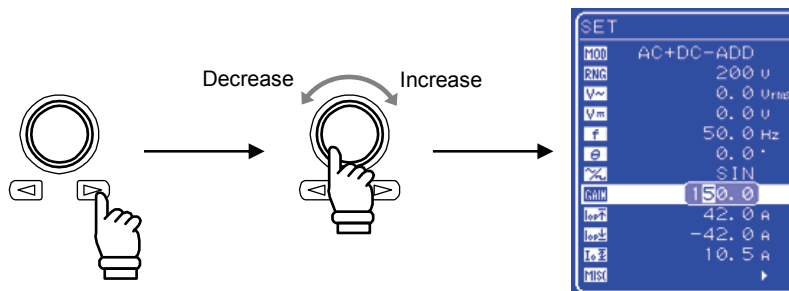

6. Press the  and  keys to move the cursor to the column to be changed, turn the MODIFY dial and set a numerical value.

⇒ The set value is reflected immediately in the output.



7. After entering all of the values, press the  or  key to close the modification box.



b) Signal input

The setup for external input is completed once the above operations and the settings are done. Now connect the signal source and input the signal.

If the input signal exceeds the maximum voltage that can be output, the output overvoltage protection function will operate, in which case output may be turned off and the waveform may become distorted.

Caution is therefore required concerning the input voltage level and the external input gain.

⚠ CAUTION

- To avoid clipping of the output voltage, use an input voltage of ± 2.2 V or less.
Also, to prevent problems in this product input block, do not allow the input voltage to exceed ± 5.5 V.
 - When using external input mode, the following functions and keys cannot be used.
 - Output voltage setting  See “5.3.3 Setting output voltage”.
 - Output frequency setting  See “5.3.4 Setting output frequency”.
 - Memory  See “4.8 Using Memory Functions”.
-

4.10 Adding External Signals and Internal Signals

When in the APS-1102 internal + external mode (AC-ADD, AC+DC-ADD), the internal signal source signal can be added to the external signal input prior to output.

When using a signal input from an external source as a signal source, connect to the rear panel external signal input/external sync signal input terminal (EXT SIG IN/EXT SYNC IN).

For this connection, use a coaxial cable with a BNC connector.

The input impedance is 10 k Ω (unbalanced), and the input frequency ranges from DC to 500 Hz.

☞ See “4.9 Amplification of External Signal”.

For description of the External signal input/external sync signal input terminal specifications:

☞ See “3.3.4 External signal input/external sync signal input terminal”.



The setting ranges for output voltage and output frequency can be limited.

☞ See “3.4.7 Using limiter functions”.



☞ See “5.5.5 Setting range limiter (LIMIT)”.

■ Operation steps

Select **MOD** “output mode” in the SET menu, then select internal + external mode (AC-ADD and AC+DC-ADD).

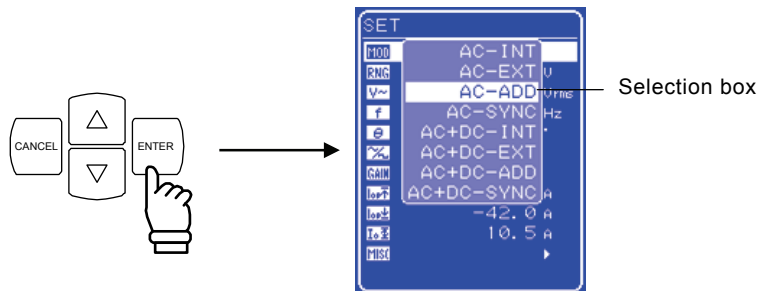
1. Press the  or  key to move the cursor to the **MOD** icon, then press the  key.
⇒ The selection box is displayed.



2. Press the  or  key to move the cursor to the mode to be set, then press the  key.
⇒ This sets the selected output mode.

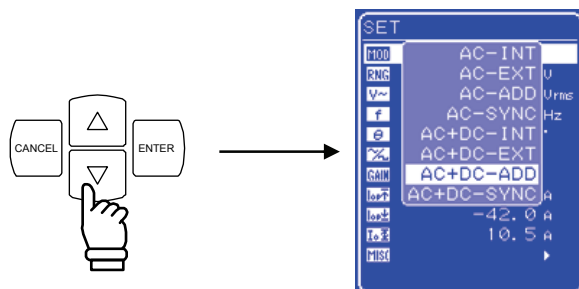

5. MENUS

5.1	Screen Configuration	5-3
5.1.1	Status icons	5-5
5.1.2	Warnings and error messages	5-6
5.1.3	Sequence display	5-6
5.2	Basic Operations	5-7
5.2.1	Menus	5-7
5.2.2	Navigating the menu tree	5-12
5.2.3	Numerical value input operations	5-13
5.2.4	Selection and input operations that require confirmation	5-13
5.2.5	EXEC input	5-14
5.2.6	Shortcut keys	5-14
5.3	SET Menu	5-15
5.3.1	Output mode setting	5-16
5.3.2	Output voltage range setting	5-17
5.3.3	Setting output voltage	5-18
5.3.4	Setting output frequency	5-19
5.3.5	Output initial phase settings	5-19
5.3.6	Waveform settings	5-19
5.3.7	Output peak current limiter settings	5-20
5.3.8	Output average current limiter settings	5-21
5.4	MEASURE Screen	5-22
5.4.1	Output voltage measurement	5-23
5.4.2	Output current measurement	5-24
5.4.3	Output power measurement	5-25
5.4.4	Load power factor measurement	5-25
5.4.5	Load crest factor measurement	5-25
5.4.6	Output harmonic current measurement	5-26
5.4.7	External synchronization frequency measurement	5-26
5.5	MISC Menu	5-27
5.5.1	Sequence (SEQUENCE)	5-27
5.5.2	Memory (MEMORY)	5-31
5.5.3	Remote (REMOTE)	5-32
5.5.4	System (SYSTEM)	5-32
5.5.5	Setting range limiter (LIMIT)	5-33
5.5.6	Selection of measurement display (MEASURE)	5-34
5.5.7	Reset of peak current hold value	5-34
5.5.8	Output on/off	5-35
5.6	System Menu	5-36

5.6.1	Keylock.....	5-38
5.6.2	Beep sound.....	5-39
5.6.3	LCD contrast adjustment.....	5-40
5.6.4	LCD display color setting.....	5-41
5.6.5	Time unit setting	5-42
5.6.6	Output on/off setting at power-on	5-43
5.6.7	External control input enable/disable setting	5-44
5.6.8	Reset function.....	5-45
5.6.9	System information	5-45

5.1 Screen Configuration

The LCD on the control panel splits in multiple windows, as is shown in **Figure 5-1** and **Figure 5-2**.

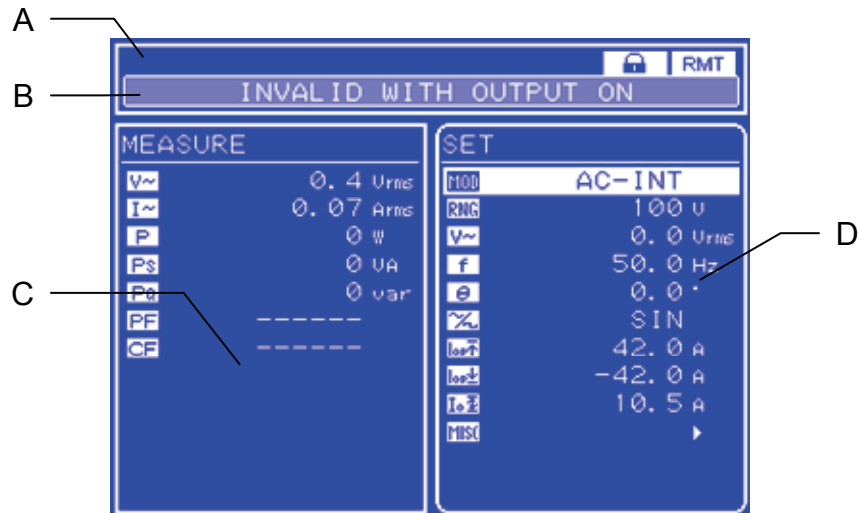

Figure 5-1. LCD Screen (When Normal)

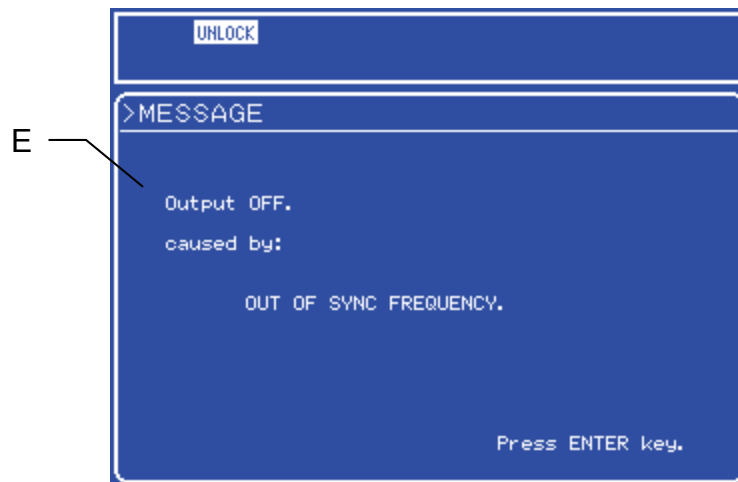

Figure 5-2. LCD Screen (When Warning Is Displayed)

The following information is displayed in various parts of the screen.











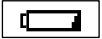



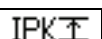
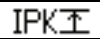

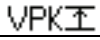
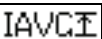
- A: Status window: This window shows the status of various devices.
- B: Message box: When an error has occurred, a message box appears near the bottom of the status window, and the cause is displayed. The message box is closed automatically after 1.5 seconds. It is also used to indicate an overload, as well as the progress of a sequence.
- C: Measured value window: This window displays measured values.
When measuring harmonic current, the data for both C and D is shown in this window.
- D: Menu window: This window is used to enter settings.
- E: Message display window: A warning message is displayed in this message window whenever there is an error that requires confirmation by the user. The displayed information remains until the ENTER key has been pressed.

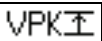
5.1.1 Status icons

The status window displays status icons that indicate the status of the APS-1102.

These status icons are listed below in **Table 5-1**.

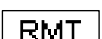
Table 5-1. Status Icons List

Icon	Item	Description
	Battery almost depleted	When a backup memory checksum error occurs, this icon flashes to indicate that the battery is almost depleted.
	Unlock	This icon goes on when external line synchronization is disabled.
	Calibration data valid/invalid	This icon flashes when the calibration data is invalid (uncalibrated).
	Busy	This icon goes on to indicate busy status.
	Limiter operations	<p>These icons are displayed in the same positions on the control panel. When the limiter operates, the displayed icons change as shown below.</p> <p>During peak current limiter operation:  appears.</p> <p>During average current limiter operation:  appears.</p> <p>During power limiter operation:  appears.</p> <p>During voltage peak limiter operation:  appears.</p>
		
		
		
	Sequence is being executed	<p>These icons are displayed in the same positions on the control panel. The displayed icons change as shown below according to the sequence status.</p> <p>In Idle mode: Nothing is displayed.</p>
	Sequence hold	<p>In Run mode:  is displayed.</p> <p>In Hold mode:  is displayed.</p>
	Keylock	This icon goes on when keylock is on.
	Remote	<p>The displayed icons change as shown below according to the APS-1102 status.</p> <p>Local: Nothing is displayed.</p> <p>Remote:  is displayed.</p>

5.1.2 Warnings and error messages

When a warning or error occurs, an error message is displayed in a message box or message display window.

 See “7 TROUBLESHOOTING”, for further description of error messages.

5.1.3 Sequence display

The APS-1102 is equipped with a function that indicates the progress of the sequence being executed. The information listed in **Table 5-2** is displayed in the status window.

Table 5-2. Sequence Display

Message	Description	Remark
SEQUENCE: RUNNING / STEP ***.	Sequence is being executed	*** Indicates step number being executed.
SEQUENCE: HOLDING / STEP ***.	Sequence is being held	*** Indicates step number being held.
SEQUENCE: FINISH	Sequence has been completed	Is closed automatically after two seconds.

5.2 Basic Operations

The APS-1102 basic operations are described below.

5.2.1 Menus

The APS-1102 uses a hierarchical menu system for setting various parameters. Menu operations are performed using the menu window in the LCD screen.

Figure 5-3 illustrates the APS-1102 menu tree.

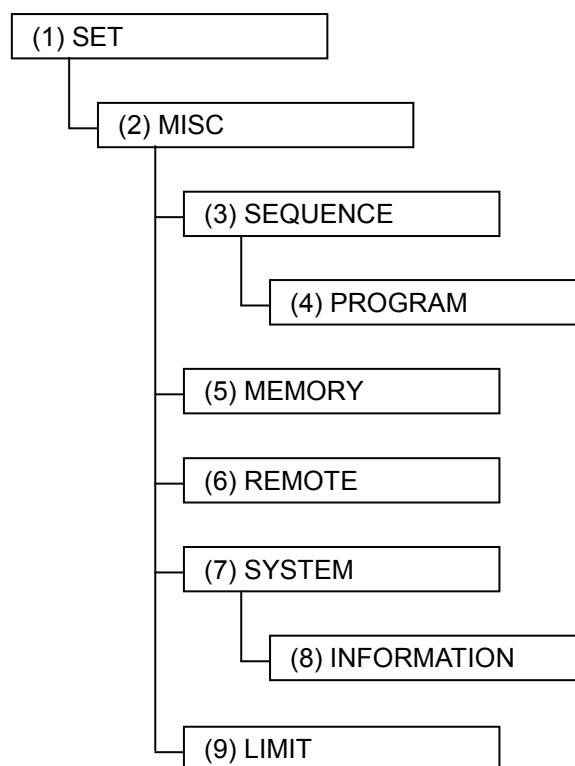

Figure 5-3. Menu Tree

The items in these menus are listed in **Table 5-3** to **Table 5-9**.

Table 5-3. Items in SET Menu



























Icon	Item	Reference
	Select output mode	 See “5.3.1 Output mode setting”.
	Select output voltage range	 See “5.3.2 Output voltage range setting”.
	Set AC voltage to be output	 See “5.3.3 Setting output voltage”.
	Set DC voltage to be output	 See “5.3.3 Setting output voltage”.
	Set frequency to be output	 See “5.3.4 Setting output frequency”.
	Set phase when output is on	 See “5.3.5 Output initial phase settings”.
	Set waveform to be output	 See “5.3.6 Waveform settings”.
	Select external sync signal source	 See “4.7 Synchronization of Output to External Signal”.
	Set external input gain	 See “4.9 Amplification of External Signal”.
	Set output peak current limit value (positive)	 See “5.3.7 Output peak current limiter settings”.
	Set output peak current limit value (negative)	 See “5.3.7 Output peak current limiter settings”.
	Set output average current limit value	 See “5.3.8 Output average current limiter settings”.
	Set use of other functions, and miscellaneous items	 See “Table 5-4. Items in MISC Menu”.

Table 5-4. Items in MISC Menu









Setting Name	Setting	Reference
SEQUENCE	Open sequence menu	 See “5.5.1 Sequence (SEQUENCE)”.
MEMORY	Open memory menu	 See “5.5.2 Memory (MEMORY)”.
REMOTE	Open remote menu	 See “5.5.3 Remote (REMOTE)”.
SYSTEM	Open system menu	 See “5.5.4 System (SYSTEM)” and “5.6 System Menu”.
LIMIT	Open setting range limit menu	 See “5.5.5 Setting range limiter (LIMIT)”.
MEASURE	Select measurement display	 See “5.5.6 Selection of measurement display (MEASURE)”.
RESET I _{pkh}	Reset peak current hold value	 See “5.5.7 Reset of peak current hold value”.
OUTPUT	Select output on/off	 See “5.5.8 Output ”.

Table 5-5. Items in SEQUENCE Menu

Setting Name	Setting	Reference
CONTROL...	Control sequence operation	See “4.4.4 Control of sequence operations”.
PROGRAM		
STEP	Step number	See “4.4.3 Programming sequence”.
TIME	Step time	
DC VOLT	DC voltage	
	DC operation type	
AC VOLT	AC voltage	
	AC operation type	
FREQ	AC frequency	
	AC frequency operation type	
WAVE	Waveform	
	Waveform operation type	
PHS	Step start phase	
	Phase operation type	
SYNC CODE	Step synchronized output	
	Step synchronized output operation type	
STOP PHS	Step end phase valid/invalid	
	Step end phase	
STEP TERM	Step end	
JUMP STEP	Jump step	
JUMP NUM	Jump times	
BRANCH0	Branch step 0	
BRANCH1	Branch step 1	
MEMORY...	Clear sequence memory	See “4.4.5 Clear sequence memory”.

Table 5-6. Items in MEMORY Menu

Setting Name	Setting	Reference
STORE...	Store settings	See “5.5.2 Memory (MEMORY)”.
RECALL...	Recall settings	
CLEAR...	Clear settings	

Table 5-7. Items in REMOTE Menu

Setting Name	Setting	Reference
LOCAL...	Switch to local mode	 See “5.5.3 Remote (REMOTE)”.

Table 5-8. Items in SYSTEM Menu











Setting Name	Setting	Reference
KEYLOCK	Keylock	 See “5.6.1 Keylock”.
BEEP	Beep	 See “5.6.2 Beep sound”.
CONTRAST	LCD contrast	 See “5.6.3 LCD contrast adjustment”.
COLOR	LCD display color	 See “5.6.4 LCD display color setting”.
TIME UNIT	Time unit	 See “5.6.5 Time unit setting”.
INIT OUT	Output on/off at power-on	 See “5.6.6 Output on/off setting at power-on”.
EXT CONTROL	External control input enable/disable	 See “5.6.7 External control input enable/disable setting”.
RESET...	Reset	 See “5.6.8 Reset function”.
INFORMATION	Display system information	 See “5.6.9 System information”.

Table 5-9. Items in LIMIT Menu

Setting name	Setting	Reference
+Vo LIMIT	Positive voltage setting limit	 See “5.5.5 Setting range limiter (LIMIT)”.
-Vo LIMIT	Negative voltage setting limit	
+ f LIMIT	Frequency setting upper limit	 See “Table 3-10. Voltage and Frequency Setting Range Limit”.
-f LIMIT	Frequency setting lower limit	

5.2.2 Navigating the menu tree

Use the UP and DOWN keys to move among items displayed in the menu windows. Press the ENTER key to go to a lower-level menu in the menu tree and press the CANCEL key to go to the higher-level menu.

■ Operation steps

The specific operation steps are as follows.

1. Use the UP and DOWN keys to move the menu cursor displayed in the menu window, then select a menu item that is marked along the right with a ► symbol.
2. At this point, pressing the ENTER key will move the cursor to a lower-level menu.
3. Now, if the CANCEL key is pressed, the cursor will go back to the higher-level menu.
4. If the CANCEL key is pressed multiple times, it will eventually return to the cursor to the top menu.

There is also a TOP MENU key among the shortcut keys. Pressing this key once will move the cursor to the top menu.

5.2.3 Numerical value input operations

When input of numerical values is required, the modification box is displayed.

When the modification box is opened, the digit cursor is displayed in one column. Use the DIGIT key to move the digit cursor and use the MODIFY key to increase or decrease values. Each time the MODIFY key is used to change a value in the modification box, the actual setting is updated immediately. The modification box is closed when either the ENTER key or the CANCEL key input.

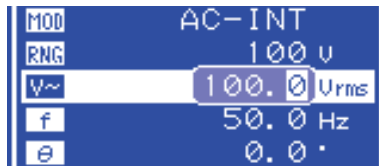

Figure 5-4. Modification Box

5.2.4 Selection and input operations that require confirmation

The selection box is displayed when selecting and setting an item from among multiple items.

When the selection box is opened, the selection cursor is displayed at one of the items. The items are listed vertical, so use the UP and DOWN keys to move the selection cursor.

If there are too many items to fit in the selection box, a ▲ will be displayed at the top line or a ▼ will be displayed at the bottom line. Each time the UP or DOWN key is pressed, the item list is scrolled one line up or down. The selection cursor does not move to the ▲ or ▼.

When the ENTER key is pressed, the setting is actually updated, and the selection box is closed. If the selection box is closed by pressing the CANCEL key, any changed settings become invalid.

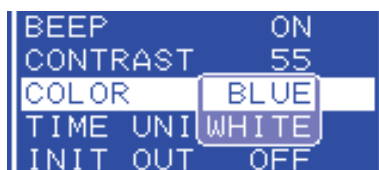

Figure 5-5. Selection Box

5.2.5 EXEC input

The EXEC box is displayed for items to be actually executed by pressing the ENTER key.

Only one target item is displayed in the EXEC box, and the cursor is shown on that item.

When the ENTER key is pressed, the item is actually executed, and the EXEC box is closed. If the EXEC box is closed by pressing the CANCEL key, nothing is executed.



Figure 5-6. EXEC Box

5.2.6 Shortcut keys

The APS-1102 shortcut keys can be used to perform the following operations.

Table 5-10. Shortcut Keys

Key No.	Indication on Control Panel	Function
1	TOP MENU	Goes back to normal display (top of menu)
2	START	Starts sequence
3	STOP	Stops sequence
4	HOLD	Holds (pauses) sequence
5	LOCAL	Returns to local mode

 See “4.4 Using the Sequence Function”, for description of the functions of keys 2 to 4.



























 See “5.5.3 Remote”, for description of the function of key 5.

5.3 SET Menu

The SET menu in the menu window is used to set basic functions.

The available settings differ according to the output mode.

Table 5-11. SET Menu Items and Output Modes

Item		Output Mode							
		AC				AC+DC			
		INT	EXT	ADD	SYNC	INT	EXT	ADD	SYNC
	Selection of output mode  See “5.3.1 Output mode setting”.	√	√	√	√	√	√	√	√
	Selection of output voltage range  See “5.3.2 Output voltage range setting”.	√	√	√	√	√	√	√	√
	Setting of AC voltage to be output  See “5.3.3 Setting output voltage”.	√		√	√	√		√	√
	Setting of AC voltage to be output  See “5.3.3 Setting output voltage”.					√		√	√
	Setting of frequency to be output  See “5.3.4 Setting output frequency”.	√		√		√		√	
	Setting of phase when output is on  See “5.3.5 Output initial phase settings”.	√		√	√	√		√	√
	Selection of waveform to be output  See “5.3.6 Waveform settings”.	√		√	√	√		√	√
	Selection of external sync signal source  See “4.7 Synchronization of Output to External Signal”.				√				√
	External input gain setting  See “4.9 Amplification of External Signal”.		√	√			√	√	
	Output peak current limit value (positive) setting  See “5.3.7 Output peak current limiter settings”.	√	√	√	√	√	√	√	√
	Output peak current limit (negative) setting  See “5.3.7 Output peak current limiter settings”.	√	√	√	√	√	√	√	√
	Output average current limit value setting  See “5.3.8 Output average current limiter settings”.	√	√	√	√	√	√	√	√
	Use of other functions and detailed settings  See “Table 5-4. Items in MISC Menu”.	√	√	√	√	√	√	√	√

5.3.1 Output mode setting

Table 5-12 lists the eight output modes that can be selected (based on combinations of two operation modes and four signal source modes).

The mode cannot be changed when output is on. Turn output off before entering settings.

Table 5-12. Output Modes

Operation Mode	Signal Source Mode	Output Mode
AC (alternate current)	INT (internal)	AC-INT
	EXT (external)	AC-EXT
	ADD (internal + external)	AC-ADD
	SYNC (external synchronization)	AC-SYNC
AC+DC (direct current)	INT (internal)	AC+DC-INT
	EXT (external)	AC+DC-EXT
	ADD (internal + external)	AC+DC-ADD
	SYNC (external synchronization)	AC+DC-SYNC

■ Selection of operation mode

The APS-1102 enables selection between two operation modes: AC (alternate current) and AC+DC (direct current).

- AC: In this mode, the APS-1102 is used as an AC constant voltage source. The voltage supplied to the load is proportionate to the set value or the input signal. The DC component is removed.
- AC+DC: In this mode, the APS-1102 is used as a DC constant voltage source. The voltage supplied to the load is proportionate to the set value or the input signal.

■ Selection of signal source

The APS-1102 enables selection of four signal source modes: INT (internal), EXT (external), ADD (internal + external), and SYNC (external synchronization).

- INT: The APS-1102 internal signal source is used. DC or AC set via the control panel menu is output.
- EXT: Signals from an external signal that is connected to the external signal input/external sync signal input terminal (EXT SIG IN/EXT SYNC IN) on the rear panel are output as external input gain amplified signals.
- ADD: In this mode, a waveform comprised of the above INT and EXT signal sources is output.
- SYNC: In this mode, the output waveform is synchronized with either an external sync signal source (TTL) connected to the external signal input/external sync signal input terminal (EXT SIG IN/EXT SYNC IN) on the rear panel or the input power line.

Figure 5-7 shows a block diagram of the APS-1102 signal sources.

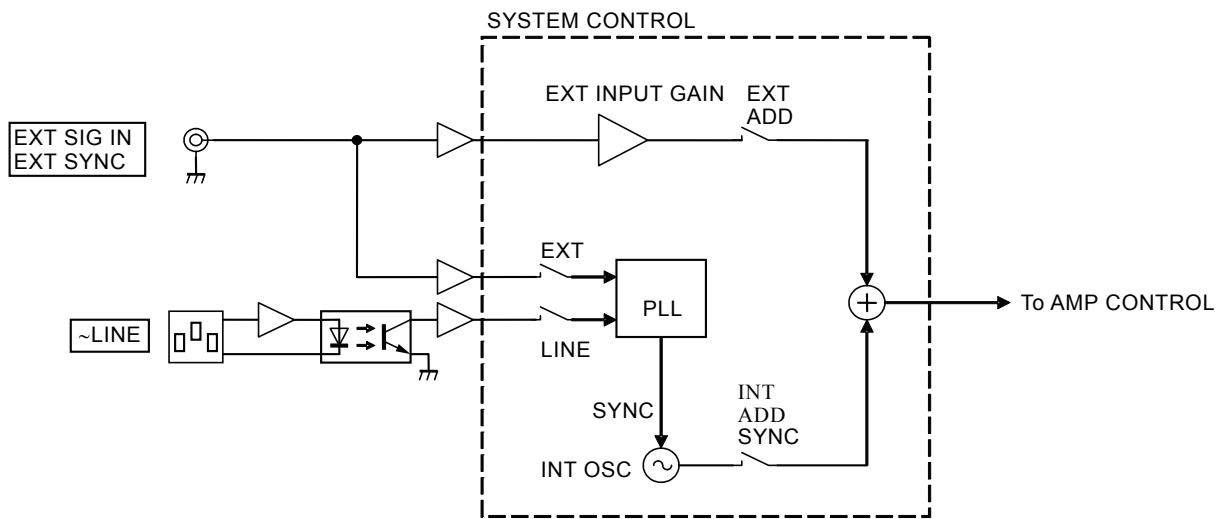

Figure 5-7. Block Diagram of Signal Sources

■ **Operation steps**

Select **100** in the SET menu.

☞ See “3.4.2 Setting output mode”, for how to select the output mode.

5.3.2 Output voltage range setting

Select 100 V or 200 V as the output voltage range.

The output voltage range cannot be changed when output is on.

The output voltage setting, current limiter setting, etc., vary according to the output voltage range setting.

☞ See “Table 4-2. Setting Range Options for Various Output Voltage Ranges”.

Output voltage range settings are retained for each operation mode (AC and AC+DC).

■ **Operation steps**

To set the output voltage range, select **RNG** in the SET menu.

For description of output voltage range settings:

☞ See “3.4.3 Setting output voltage range”.

☞ See “4.1.3 Setting the output voltage range”.

5.3.3 Setting output voltage



The output voltage settings listed below can be made for the two operation modes.

Table 5-13. Output Voltage Settings

Operation Mode	Setting		Setting Range	Resolution
AC mode (AC-INT, AC-ADD, AC-SYNC)	AC voltage	100 V range	0.0 to 140.0 Vrms	0.1 Vrms
			0.0 to 400.0 Vp-p	0.1 Vp-p
	200 V range	0.0 to 280.0 Vrms	0.1 Vrms	
		0.0 to 800.0 Vp-p	0.1 Vp-p	
AC+DC mode (AC+DC-INT, AC+DC-ADD, AC+DC-SYNC)	DC voltage	100 V range	-200.0 to +200.0 V	0.1 V
		200 V range	-400.0 to +400.0 V	0.1 V
	AC voltage	100 V range	0.0 to 140.0 Vrms	0.1 Vrms
			0.0 to 400.0 Vp-p	0.1 Vp-p
		200 V range	0.0 to 280.0 Vrms	0.1 Vrms
			0.0 to 800.0 Vp-p	0.1 Vp-p

When the selected AC voltage waveform is either SIN (sine wave) or SQU (square wave), the AC voltage setting is made in Vrms units. When it is ARB (arbitrary waveform) 1 to 16, this setting is made in Vp-p units.

■ Operation steps

Select either  “AC voltage” or  “DC voltage” in the output voltage SET menu then set a numerical value.

 See “3.4.5 Setting output voltage”, for description of output voltage setting.

 See also “4.1.4 Setting the output voltage”.

5.3.4 Setting output frequency

This sets the AC voltage frequency.

When either AC-SYNC or AC+DC-SYNC mode is selected, the AC voltage frequency cannot be set.

Table 5-14. Output Frequency Setting

Setting Range	Resolution	Setting Accuracy
1.0 Hz to 550.0 Hz	0.1 Hz	± 100 ppm (1.0 Hz to 550.0 Hz, $23 \pm 5^\circ\text{C}$)

 See “3.4.7 Using limiter functions”, when using a setting range limit for output frequency.

■ Operation steps

To set the output frequency, set a numerical value labeled  in the SET menu.

 See “3.4.6 Setting output frequency”, for description of output frequency settings.

 See “5.5.5 Setting range limiter (LIMIT)”, for description of setting range limits.

5.3.5 Output initial phase settings

When AC-INT, AC-ADD, AC-SYNC, AC+DC-INT, AC+DC-ADD, or AC+DC-SYNC mode is selected, the AC voltage phase can be set according to the internal signal source when output is on.

Table 5-15. Output Initial Phase Settings

Setting Range	Resolution
0.0° to 359.9°	0.1°

■ Operation steps

To set the phase, select  in the SET menu and set a numerical value.

For description of the output initial phase:

 See “4.2.2 Set phase at output on”.

5.3.6 Waveform settings

When AC-INT, AC-ADD, AC-SYNC, AC+DC-INT, AC+DC-ADD, or AC+DC-SYNC mode is selected, select sine wave, square wave, or arbitrary waveform (16 types) as the waveform to be output.

Arbitrary waveforms are generated by data transfers via the USB interface.

■ Operation steps

To select a waveform, select  in the SET menu.

 See “3.4.4 Setting waveform”, for description of waveform settings.

 See the control software user’s manual, for description of arbitrary waveform transfers.

5.3.7 Output peak current limiter settings

The positive value and the negative value of the peak current limiter can be set independently.

If the output peak current exceeds the set current, the output voltage is clipped.

Setting range limits can be set for output voltage and output frequency.

 See “5.5.5 Setting range limiter (LIMIT)”.

Table 5-16. Output Peak Current Limiter Setting Range



Setting		Setting Range	Resolution	Initial Value
Output peak current limiter (positive)	100 V range	+10.0 A to +42.0 A	0.1 A	+42.0 A
	200 V range	+5.0 A to +21.0 A	0.1 A	+21.0 A
Output peak current limiter (negative)	100 V range	-42.0 A to -10.0 A	0.1 A	-42.0 A
	200 V range	-21.0 A to -5.0 A	0.1 A	-21.0 A

Limiter settings are retained separately for the 100 V and 200 V range.

Since these are not fully constant current operations, the specified limit value may not be achieved, depending on the load.

■ Operation steps

Select the icon in the SET menu, then set a numerical value.

- Output peak current limiter (positive): 
- Output peak current limiter (negative): 

 See “3.4.7 Using limiter functions”, for description of the output peak current limiter settings.

CAUTION

Note with caution that the output peak current limiter may allow overshooting, depending on the load, and therefore may not achieve the peak current value as set.

For an inductive load, operation of the limiter can cause an output overvoltage, triggering the protection function. In this case, the peak current limiter settings (positive and negative) should be reduced.

CAUTION

If the output current or frequency suddenly increases, due, for example, to an output short circuit, the limiter response may not be quick enough, so the output overcurrent protection function may be triggered.

5.3.8 Output average current limiter settings

This limits the output average current.

When the output average current exceeds this setting, the output voltage is suppressed.

Table 5-17. Output Average Current Limiter Setting Range

Setting		Setting Range	Resolution	Initial Value
Output average current limiter	100 V range	1.0 A to 10.5 A	0.1 A	10.5 A
	200 V range	1.0 A to 5.3 A	0.1 A	5.3 A

■ Operation steps

Select  in the SET menu and set numerical values.















 See “3.4.7 Using limiter functions”, for description of the output average value current limiter.

5.4 MEASURE Screen

The MEASURE screen in the measured value window displays measured values for items selected as measurement display items (some of which depend on the output mode).

The measured values for output voltage and output current are displayed as values set via “MEASURE” in the MISC menu.

Table 5-18. Display Items in MEASURE Screen

Item	Unit	Select Measurement Display	Reference
 Voltage RMS value	V _{rms} V _{p-p}	RMS	☞ “5.4.1 Output voltage measurement”
 DC voltage value	V	AVG	
 + voltage peak value	V _{pk}	PEAK	
 – voltage peak value	V _{pk}	PEAK	
 Current RMS value	A _{rms}	RMS	☞ “5.4.2 Output current measurement”
 DC current value	A	AVG	
 + current peak value	A _{pk}	PEAK	
 – current peak value	A _{pk}	PEAK	
 Current peak value hold	A _{pk}	PEAK	
 Effective power	W	Always displayed	☞ “5.4.3 Output power measurement”
 Apparent power	VA	Always displayed	
 Reactive power	var	Always displayed	
 Synchronization frequency	Hz	During external synchronization mode only	☞ “5.4.7 External synchronization frequency measurement”
 Load power factor	None	Always displayed	☞ “5.4.4 Load power factor measurement”
 Load crest factor	None	Always displayed	☞ “5.4.5 Load crest factor measurement”

5.4.1 Output voltage measurement

When “MEASURE” has been selected in the MISC menu, RMS value (RMS), average DC (AVG), or peak value (PEAK) is displayed.

The initial setting (factory setting) is to display the RMS value (RMS).

 See “3.4.9 Using measurement functions”.

- a) RMS value** **RMS value of AC+DC**
- Full scale: ± 225.0 Vrms: 100 V range
 ± 450.0 Vrms: 200 V range
 - Display resolution: 0.1 Vrms
 - Measurement accuracy: $\pm 0.5\%$ of the full scale (at $23 \pm 5^\circ\text{C}$)
- b) Average value** **Average value of AC+DC (measurement of DC)**
- Full scale: ± 225.0 V: 100 V range
 ± 450.0 V: 200 V range
 - Display resolution: 0.1 V
 - Measurement accuracy: $\pm 0.5\%$ of the full scale (at $23 \pm 5^\circ\text{C}$)
- c) Peak value** **Positive peak voltage and negative peak voltage are displayed separately**
- Full scale: +225 Vpk/–225 Vpk: 100 V range
 +450 Vpk/–450 Vpk: 200 V range
 - Display resolution: 1 Vpk
 - Measurement accuracy: $\pm 3\%$ of the full scale (at $23 \pm 5^\circ\text{C}$, sine wave)

5.4.2 Output current measurement

When “MEASURE” has been selected in the MISC menu, RMS value (RMS), average DC (AVG), or peak value (PEAK) is displayed.

The initial setting (factory setting) is to display the RMS value (RMS).

 See “3.4.9 Using measurement functions”.

a) RMS value RMS value of AC+DC

- Full scale: 15.00 Arms
- Display resolution: 0.01 Arms
- Measurement accuracy: $\pm 1.0\%$ of the full scale (at $23 \pm 5^\circ\text{C}$)

b) Average value Average value of AC+DC (measurement of DC)

- Full scale: ± 15.00 A
- Display resolution: 0.01 A
- Measurement accuracy: $\pm 1.0\%$ of the full scale (at $23 \pm 5^\circ\text{C}$)

c) Peak value Positive peak current and negative peak current are displayed separately

- Full scale: $+45.0$ Apk/ -45.0 Apk
- Display resolution: 0.1 Apk
- Measurement accuracy: $\pm 3\%$ of the full scale (at $23 \pm 5^\circ\text{C}$, sine wave)

d) Peak value hold Maximum values of | positive peak current | and | negative peak current |

The output current maximum peak value is displayed.

A reset operation returns the peak current hold value to 0 Apk.

 See “4.2 Measurement of Inrush Current”.

- Full scale: 45.0 Apk
- Display resolution: 0.1 Apk
- Measurement accuracy: $\pm 3\%$ of the full scale (at $23 \pm 5^\circ\text{C}$, sine wave)

5.4.3 Output power measurement

The output power values described below are always displayed.

a) Effective power

- Full scale: 1200 W
- Display resolution: 1 W
- Measurement accuracy: $\pm 2\%$ of the full scale (at $23 \pm 5^\circ\text{C}$)
(when output is 100 VA or above)

b) Apparent power **Calculated as output voltage RMS value \times output current RMS value**

- Full scale: 1400 VA
- Display resolution: 1 VA
- Measurement accuracy: $\pm 2\%$ of the full scale (at $23 \pm 5^\circ\text{C}$)
(when output is 100 VA or above)

c) Reactive power **Calculated as $\sqrt{\text{apparent power}^2 - \text{effective power}^2}$**

- Full scale: 1400 Var
- Display resolution: 1 Var
- Measurement accuracy: $\pm 2\%$ of full scale (at $23 \pm 5^\circ\text{C}$)
(when output is 100 VA or above)

5.4.4 Load power factor measurement

Calculated by effective power/apparent power

This measurement is always displayed.

- Measurement range: 0.00 to 1.00
- Display resolution: 0.01

5.4.5 Load crest factor measurement

Calculated by (maximum values of |positive peak current| and |negative peak current|)/effective power

This measurement is always displayed.

- Measurement range: 0.00 to 50.00
- Display resolution: 0.01

5.4.6 Output harmonic current measurement

Output harmonic current measurement is enabled only in the AC-INT mode and when the frequency setting is 50 or 60 Hz.

When HC1, HC2, HC3, or HC4 is selected under “MEASURE” in the MISC menu, the harmonic measurement window is displayed.

At that time, measurements other than output harmonic measurement are not performed. This measurement does not comply with the IEC standards.

 See “4.3 Measurement of Harmonic Current”.

- Measurement range: To 40th harmonic of fundamental wave
- Full scale: 15 Arms and 100%
- Display resolution: 0.01 Arms and 0.1%
- Measurement accuracy: $\pm 1\%$ of full scale at RMS value current (to 20th harmonic at $23 \pm 5^\circ\text{C}$),
 $\pm 1.5\%$ of full scale at RMS value current (from 20th to 40th harmonic at $23 \pm 5^\circ\text{C}$)

5.4.7 External synchronization frequency measurement

The frequency measured value is displayed only in the external synchronization mode (AC-SYNC or AC+DC-SYNC).

 See “4.7 Synchronization of Output to External Signal”.

- Measurement range: 38.0 to 525.0 Hz
- Display resolution: 0.1 Hz
- Measurement accuracy: ± 0.2 Hz (at $23 \pm 5^\circ\text{C}$, 50/60 Hz)

5.5 MISC Menu

This menu is used to enter detailed settings for various functions. These settings can be entered regardless of whether output is on or off.

5.5.1 Sequence (SEQUENCE)

A sequence menu is displayed. This menu is used to control sequences, set up programming, and clear sequence memory.

a) CONTROL...(sequence control)

Select among the sequence operation control items listed below.  See “4.4.4 Control of sequence operations”.

Table 5-19. Items in CONTROL Selection Box

Item in Selection Box	Operation
START	Starts sequence operations. Switches to Run mode.
STOP	Stops sequence operations. Switches to Idle mode.
HOLD	Holds (pauses) sequence operations. Switches to Hold mode.
BRAN0	Branches to step specified by branch step.
BRAN1	If the branch step is not specified, it is ignored.

The sequence control selection box can be selected only when output is on. If the output on/off key is pressed while this selection box is displayed, the selection box is closed.

b) PROGRAM (sequence programming)

This “PROGRAM” screen is used to program sequences.

The items listed below in **Table 5-20** to **Table 5-22** are set for individual steps.

Sequence programming is stored automatically, and the data for AC mode with a 100 V range or a 200 V range is stored separately from the data for AC+DC mode with a 100 V range or a 200 V range.

 See “4.4.3 Programming sequence”, for description of sequence programming operation steps.

Table 5-20. PROGRAM Screen Items (1/3)

Setting Name	Item	Operation
STEP	Step number	This specifies the step number to be set. Setting range: 1 to 255
TIME	Step time	Specifies the continuation time for the specified step. Setting range: 0.0001 s to 999.9999 s Setting resolution: 0.0001 s (= 0.1 ms) * The time unit can be switched between “s” and “ms” via the SYSTEM menu “TIME UNIT” setting.  See “5.6.5 Time unit setting”.
DC VOLT (AC+DC-INT only)	DC voltage value	Sets the DC voltage value for AC+DC mode. The setting range is determined by the range setting used when editing sequence data. Setting range: 100 V range: -200.00 V to +200.00 V 200 V range: -400.00 V to +400.00 V Setting resolution: 0.1 V
	DC operation type	Sets the method used to change to the specified DC voltage value. Select one of the following three options. <ul style="list-style-type: none"> • CONST: Output specified value • KEEP: Output value at end of previous step • SWEEP: Start by outputting value at end of previous step, then perform a linear sweep to output the specified value at the end of the current step
AC VOLT	AC voltage value	Sets the AC voltage value. The setting range is determined by the range setting entered when editing the sequence data. Setting range: 100 V range: 0.0 Vrms to 140.0 Vrms 0.0 Vp-p to 400.0 Vp-p 200 V range: 0.0 Vrms to 280.0 Vrms 0.0 Vp-p to 800.0 Vp-p Setting resolution: 0.1 Vrms/0.1 Vp-p * The voltage value can be set as “Vp-p” only when arbitrary waveform has been selected.
	AC operation type	Sets the method used to change to the specified AC voltage value. Select one of the following three options. <ul style="list-style-type: none"> • CONST: Output specified value • KEEP: Output value at end of previous step • SWEEP: Start by outputting value at end of previous step, previous perform a linear sweep to output the specified value at the end of the current step

Table 5-21. PROGRAM Screen Items (2/3)

Setting Name	Item	Operation
FREQ	AC frequency	Sets the AC frequency. Setting range: 1.0 Hz to 550.0 Hz Setting resolution: 0.1 Hz
	AC frequency operation type	Sets the method used to change to the specified frequency. Select one of the following three options. <ul style="list-style-type: none"> • CONST: Output specified value • KEEP: Output value at end of previous step • SWEEP: Start by outputting value at end of previous step, then perform a linear sweep to output then specified value at the end of the current step
WAVE	Waveform	Selects arbitrary waveform to be output. Setting range: SIN/SQU/ARB1 to ARB16
	Waveform operation type	Sets the method used to change to the specified waveform. Select one of the following two options. <ul style="list-style-type: none"> • CONST: Output specified waveform • KEEP: Output previous step waveform
PHS	Phase	Sets output initial phase. Setting range: 0.0° to 359.9° Setting resolution: 0.1°
	Phase operation type	Sets the method used to change to the specified phase. Select one of the following two options. <ul style="list-style-type: none"> • CONST: Output specified phase • KEEP: Output previous step phase
SYNC CODE	Step synchronized output	This sets the code (2 bits) to be output in sync with step execution. The sequence step transitions can be checked by monitoring the step synchronized output. Bit 0 is output from pin 5 (DOOUT5) of the external control I/O connector and bit 1 is output from pin 6 (DOOUT6). Select one of the following four types of step synchronized output (the numbers are displayed in the order "bit 1, bit 0"). During Idle mode, these values are "0, 0". <ul style="list-style-type: none"> • 0, 0 • 0, 1 • 1, 0 • 1, 1
	Step synchronized output operation type	Specifies the output method for step synchronized output. Select one of the following two options. <ul style="list-style-type: none"> • CONST: Output specified code • KEEP: Output same code as at previous step
STOP PHS	Step end phase enable/disable	Specifies step end phase as enabled or disabled. Select one of the following two options. <ul style="list-style-type: none"> • DISABLE: Disable (phase depends on step time) • ENABLE: Enable
	Step end phase	Sets step end phase. Setting range: 0.0° to 359.9° Setting resolution: 0.1°

Table 5-22. PROGRAM Screen Items (3/3)

Setting Name	Item	Operation
STEP TERM	Step end	Sets operation after end of step. Select one of the following three options. <ul style="list-style-type: none"> • CONT: Sequence continuation • STOP: Change to Idle mode • HOLD: Change to Hold mode
JUMP STEP	Jump step	Sets the step number to jump to after the end of the previous step. <ul style="list-style-type: none"> • 0: Continue to next step number • 1 to 255: Jump to specified step number
JUMP NUM	Jump times	Sets the number of times to execute the jump operation specified by JUMP STEP. <ul style="list-style-type: none"> • 0: Unlimited jumps • 1 to 999: Specified number of jumps
BRANCH0	Branch step 0	Sets the step number to jump to when trigger input has occurred. Two types of branch steps can be set: BRANCH0 and BRANCH1. [Command example]
BRANCH1	Branch step 1	When a STOP is set after a small number of sweeps at the jump destination step, it enables uses where there is a safe region for saving data if necessary. <ul style="list-style-type: none"> • 0: Branch disabled • 1 to 255: Jump to specified step number

c) MEMORY...(clears sequence memory)

This clears the sequence memory.

When this cleared, the initial value is input.

 See "4.4.5 Clear sequence memory".

 See "Table 3-1. Settings in Memory".

5.5.2 Memory (MEMORY)

The “MEMORY” screen is used to control memory.

Settings saved (stored) to store/recall memory No. 1 to No. 30 can be recalled and used.

Recall of store/recall memory contents can be executed only when output is off.

 See “4.8 Using Memory Functions”, for description of store/recall memory.

After selecting one of the following operations, use the selection box to specify the target memory number.

- STORE...: Stores settings to specified memory number.
- RECALL...: Recalls settings from specified memory number.
- CLEAR...: Clears settings in specified memory number.

5.5.3 Remote (REMOTE)

The remote control connected via a USB interface can be used to switch to local mode for operation via the panel screen.

When in remote control mode, the “RMT” icon is displayed.

See “6 USB INTERFACE”.

■ Operation steps

1. Select “LOCAL...”, then press the key.
⇒ The EXEC box is displayed.

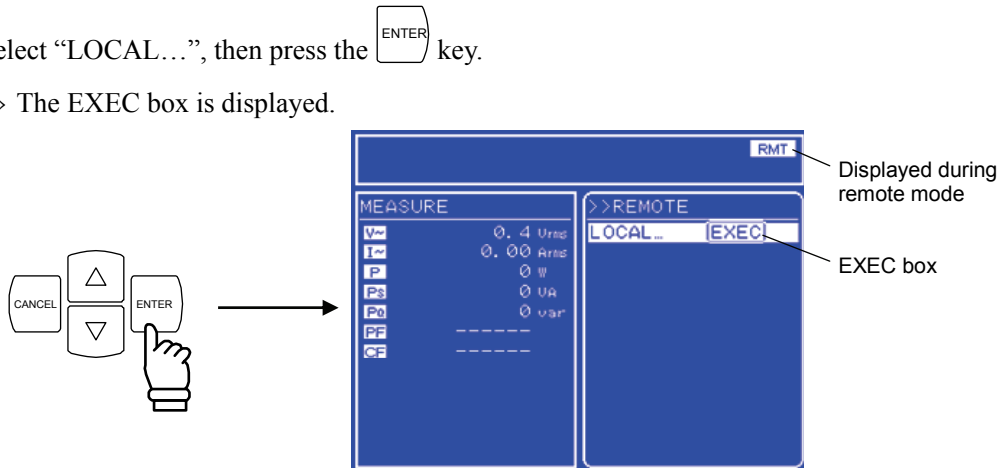

2. Make sure “EXEC” has been selected, then press the key.
⇒ This sets local mode.

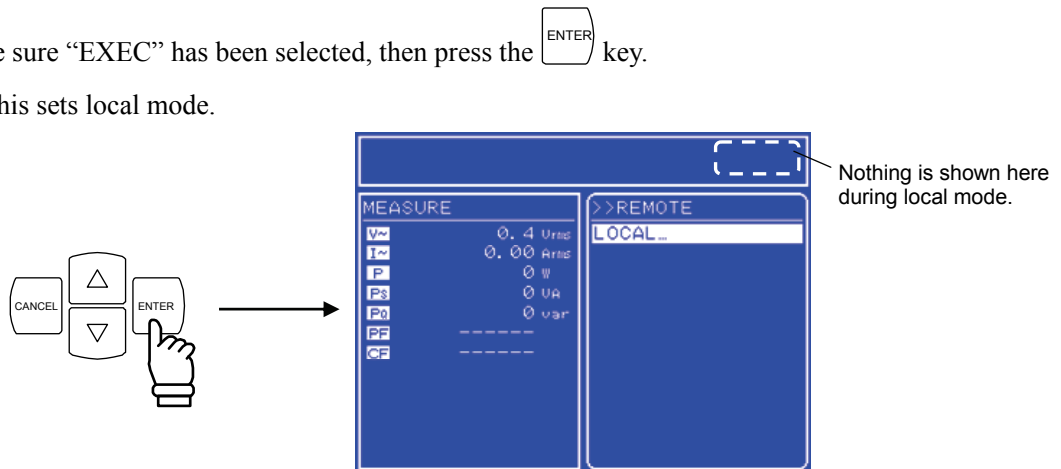

5.5.4 System (SYSTEM)

The APS-1102 system settings are displayed in the “SYSTEM” screen.

See “5.6 System Menu”, for detailed description of the system menu.

5.5.5 Setting range limiter (LIMIT)

The setting range limiter indicates the LIMIT screen, enabling the setting range of output voltage and output frequency to be limited when the signal source mode is the internal signal source mode (AC-INT, AC+DC-INT) or internal + external signal source mode (AC-ADD, AC+DC-ADD), and the setting range of the output voltage to be limited when in the external sync mode (AC-SYNC, AC+DC+SYNC).

The numeric values shown in **Table 5-23** are set on this screen.

 See b) Using setting range limit in “3.4.7 Using limiter functions”.

Table 5-23. Setting Range Limit (LIMIT)

Setting Name	Setting	Output Voltage Range	Setting Range	Resolution	Initial value	Unit
+Vo LIMIT	Positive voltage setting limit	100 V	+5.0 to +200.0	0.1	+200.0	V
		200 V	+10.0 to +400.0	0.1	+400.0	V
-Vo LIMIT	Negative voltage setting limit	100 V	-200.0 to -5.0	0.1	-200.0	V
		200 V	-400.0 to -10.0	0.1	-400.0	V
+ f LIMIT	Frequency setting upper limit		1.0 to 550.0	0.1	550.0	Hz
- f LIMIT	Frequency setting lower limit		1.0 to 550.0	0.1	1.0	Hz

- The setting range limit sets the limit for AC peak value + DC.
For example, when +Vo limit is +200.0 V, and the DC setting has already been set to 100.0 V, the AC limit setting becomes 70.7 Vrms (100.0 Vpk).
- The setting range limit cannot set to a value that sets the currently set value outside of the range.
- The same setting range limit is used for all output modes. Not only the currently selected output mode setting, but the settings for all other modes are restricted by this limit. (The APS-1102 stores the setting for each output mode.)

The following describes an example where the selected output mode is AC-INT and the limit is set to prevent the output voltage from exceeding 100.0 Vrms.

In this case, the output limit range must be set to ± 141.4 V (100.0 Vrms), but this setting cannot be made unless the output voltage setting is 100.0 Vrms or less for the other output modes where the output voltage can be set, i.e., the AC-ADD, AC-SYNC, AC+DC-INT, AC+DC-ADD, and AC+DC-SYNC modes. If the setting for AC-ADD is 110.0 Vrms, the setting range limit cannot be set within ± 155.5 V (110.0 Vrms), even if the setting for the selected AC-INT is 100.0 Vrms. Memory and sequences are not subject to setting range limits.

5.5.6 Selection of measurement display (MEASURE)

Select the measured values to be displayed, from the RMS value (RMS), average DC (AVG), peak value (PEAK), and harmonic current values (HC1 to HC4).

When harmonic current value is selected, the RMS value, average DC, and peak value are not measured.

When measurement of the RMS value, average DC, or peak value has been set, harmonic current is not measured.

 See “3.4.9 Using measurement functions”, for description of measurement display selection.

 See “4.3 Measurement of Harmonic Current” and

“5.4.6 Output harmonic current measurement”, for description of harmonic current measurement.

5.5.7 Reset of peak current hold value

This resets the peak current hold value.

A reset sets the peak current hold value to 0 Apk, and then holds the new peak value.



 See “4.2.4 Reset the peak current hold value”, for description of resetting peak current hold value.

5.5.8 Output on/off

The APS-1102 output on/off setting can be entered using the  key on the front panel, but it can also be controlled via the MISC menu.

 See “3.4.8 Output on/off”.

■ **Operation steps**

1. Press the  or  key to move the cursor to “OUTPUT”.

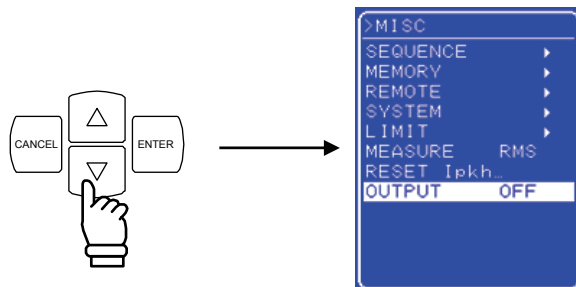

2. Press the  key to display the selection box.

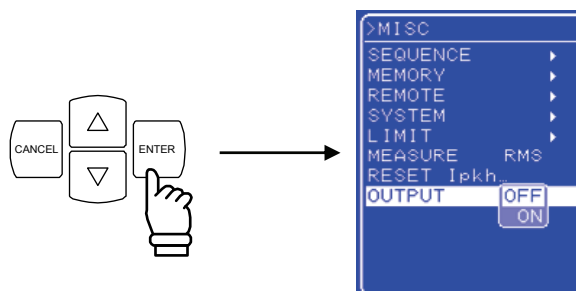

3. Press the  key to move the cursor to “ON”.

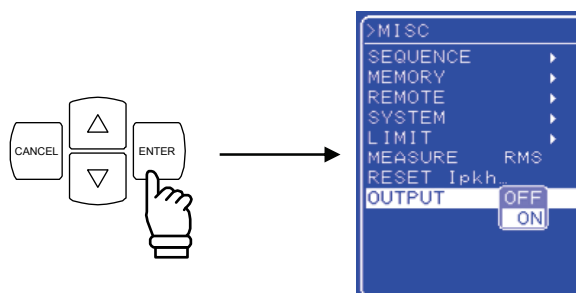

4. Press the  key to turn output on, at which time the output on/off LED goes on.

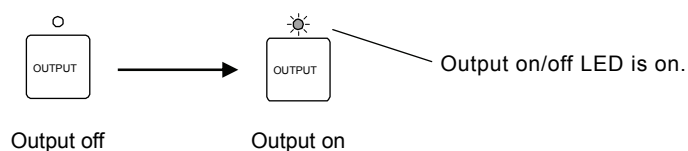



5.6 System Menu

This menu is used to enter the following system settings for the APS-1102.

- KEYLOCK: Keypadlock
- BEEP: Beep
- CONTRAST: LCD contrast
- COLOR: LCD display color
- TIME UNIT: Time unit
- INIT OUT: Output on/off at power-on
- EXT CONTROL: External control input enabled/disabled
- RESET...: Reset
- INFORMATION: System information display

■ “SYSTEM” screen display steps

Select **MISC** and then “SYSTEM” in the MISC menu.

1. Press the  or  key to move the cursor to the **MISC** icon.

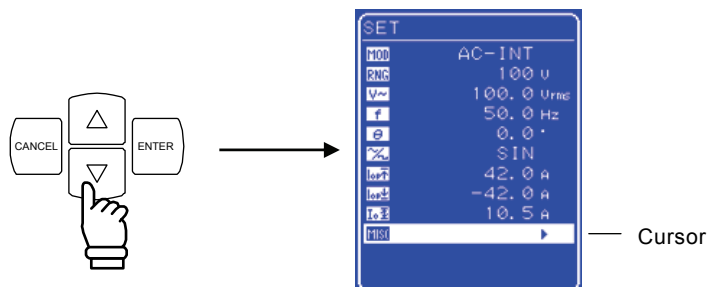

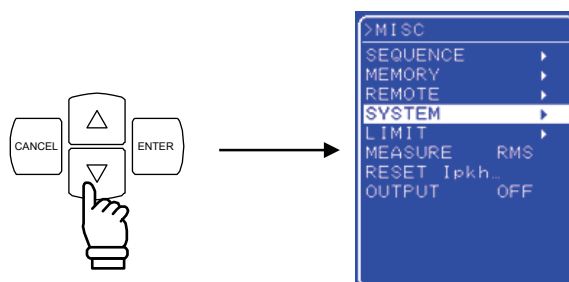

2. Press the  key to display the MISC menu.

Press the  key to move the cursor to “SYSTEM”.

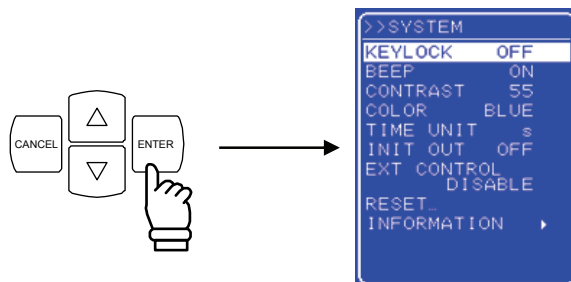

3. Press the  key to display the SYSTEM screen .





4. Press the  or  key to select the operation to be performed.

5.6.1 Keylock

The APS-1102 is equipped with a function that prevents key input errors during operation.

When “keylock” is on, all keys become inactive except for the keylock off key. Although it is possible to switch among menus when keylock is on, basically no changes can be made except for turning keylock off. However, output can still be turned off via the OUTPUT key as an emergency response measure.

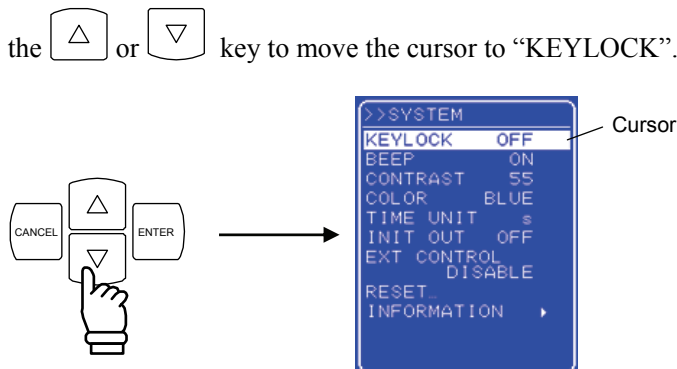

■ Operation steps

1. Press the  or  key to move the cursor to “KEYLOCK”.



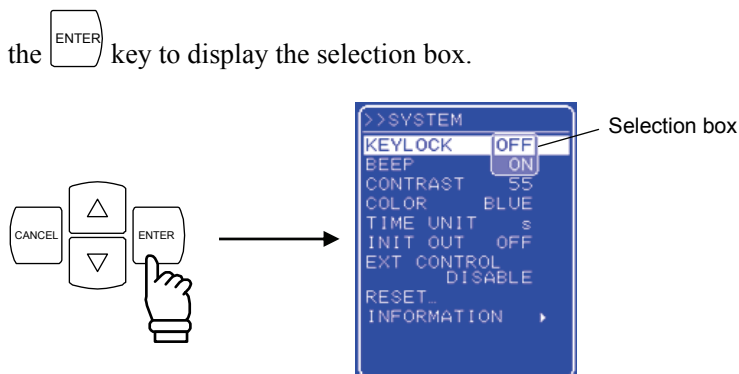

2. Press the  key to display the selection box.

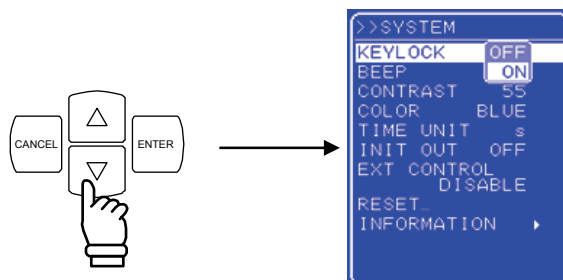

3. Press the  or  key to move the cursor to the other keylock setting (i.e., to OFF when on or to ON when off).





4. Press the  key to complete the setting. Press the  key to cancel the setting.

5.6.2 Beep sound

When the beep sound is on, a beep sounds when an incorrect operation is made, a key is pressed, or a modify operation is made. When a protection function-related error occurs, an alarm sound will be output regardless of the beep sound setting.

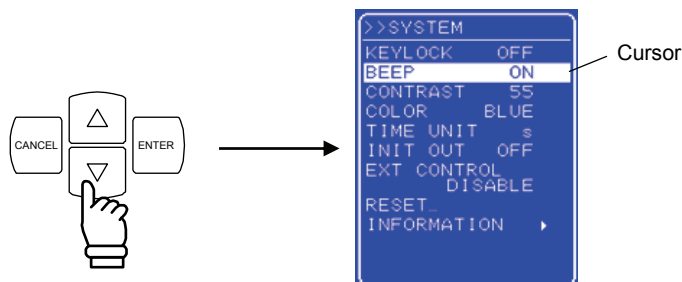

■ Operation steps

1. Press the  or  key to move the cursor to "BEEP".



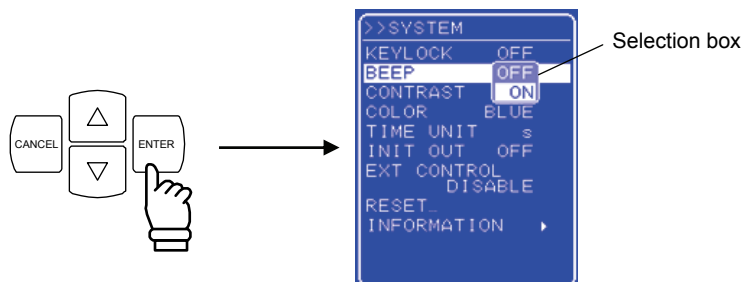

2. Press the  key to display the selection box.

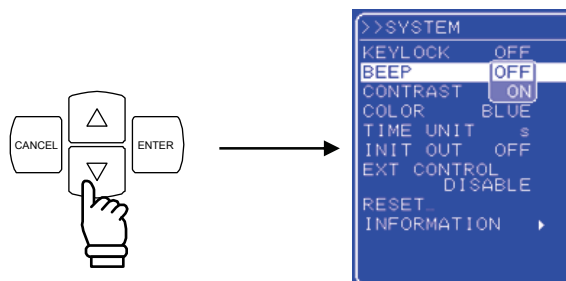

3. Press the  or  key to move the cursor to the other keylock setting (i.e., to OFF when on or to ON when off).





4. Press the  key to complete the setting. Press the  key to cancel the setting.

5.6.3 LCD contrast adjustment

The LCD screen contrast level can be set to any of 100 levels to suit the operation environment.

To open the level adjustment text box, press the ENTER key and CANCEL key at the same time. This enables the contrast to be adjusted even when the current contrast setting does not allow easy recognition of the LCD display contents. This also moves the digit cursor to the 10's place.

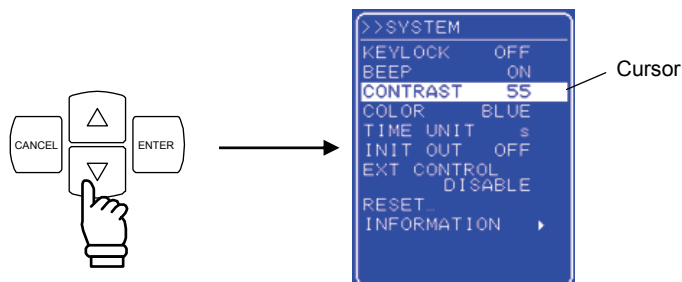

■ Operation steps

1. Press the  or  key to move the cursor to "CONTRAST".

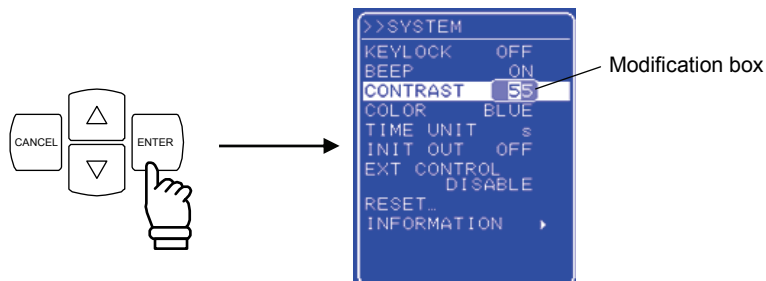

2. Press the  key to display the modification box.



3. Press the  and  keys to move the cursor to the column to be changed, turn the MODIFY dial and set a numerical value. The set value will be displayed immediately.

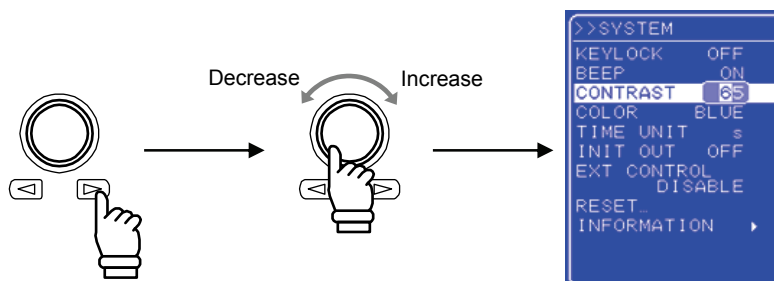



4. After setting all of the columns, press the  or  key to close the modification box.

5.6.4 LCD display color setting

The display color of the LCD screen on the control panel can be set as either blue based (white text on blue background) or white based (blue text on white background).

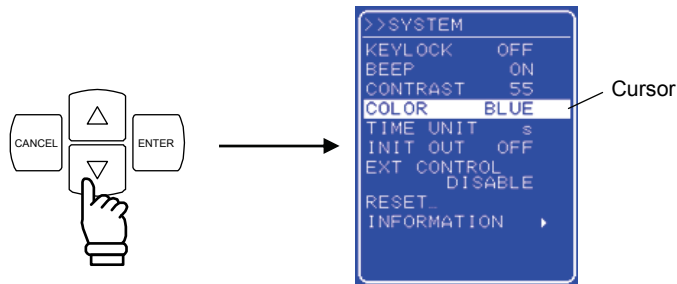

■ Operation steps

1. Press the  or  key to move the cursor to “COLOR”.



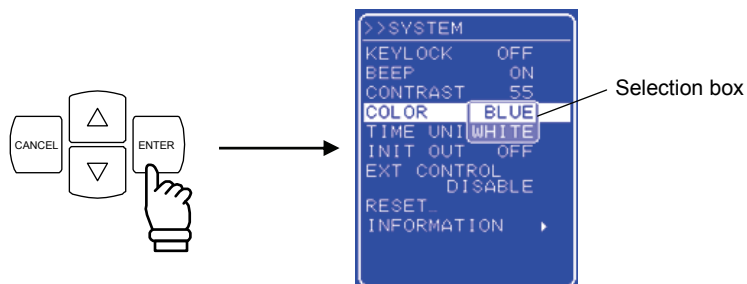

2. Press the  key to display the selection box.

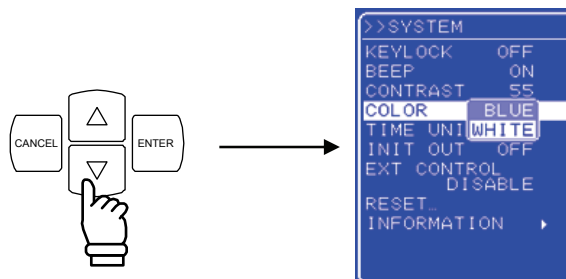

3. Press the  or  key to move the cursor to “BLUE” for blue based or “WHITE” for white based.





4. Press the  key to complete the setting. Press the  key to cancel the setting.

5.6.5 Time unit setting

The unit used to indicate the time parameter can be specified.

Select either “s” (second) or “ms” (millisecond) for this time unit.

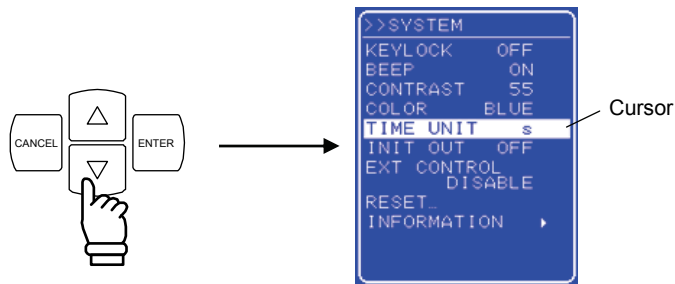

■ Operation steps

1. Press the  or  key to move the cursor to “TIME UNIT”.



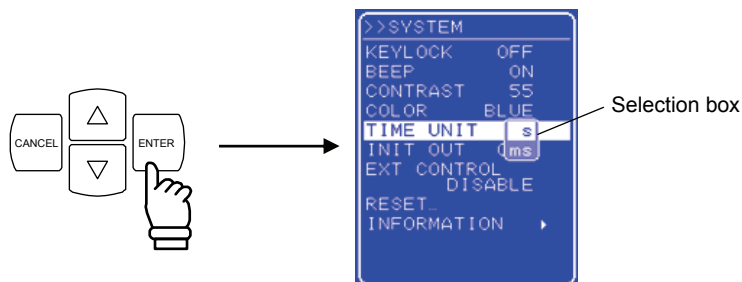

2. Press the  key to display the selection box.

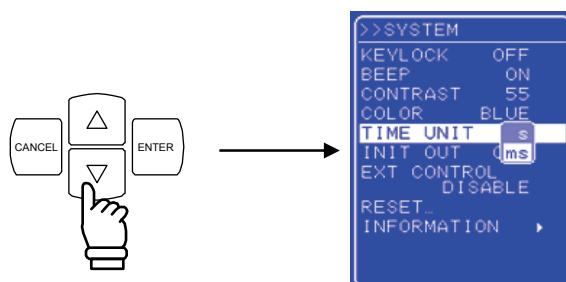

3. Press the  or  key to move the cursor to the displayed unit.





4. Press the  key to complete the setting. Press the  key to cancel the setting.

5.6.6 Output on/off setting at power-on

The APS-1102 can be set to automatically turn output on at power-on.

However, when restarting after a system lock, the APS-1102 will start with output off regardless of this setting.

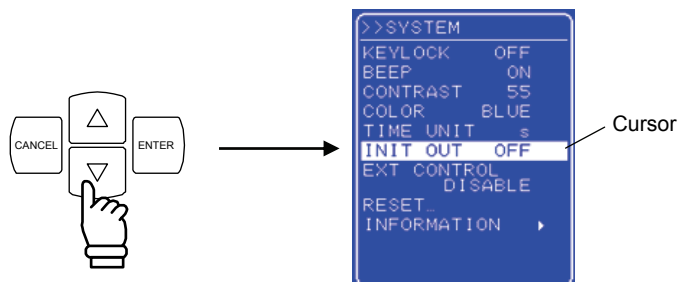

■ Operation steps

1. Press the  or  key to move the cursor to "INIT OUT".



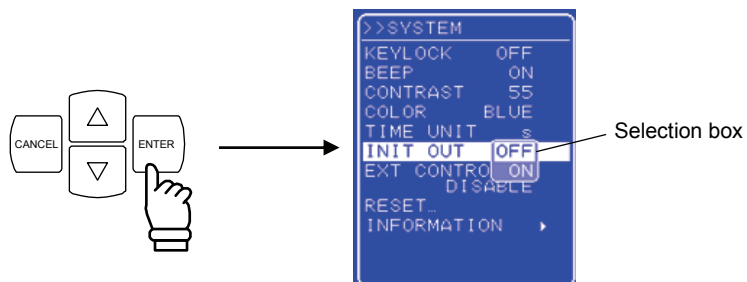

2. Press the  key to display the selection box.

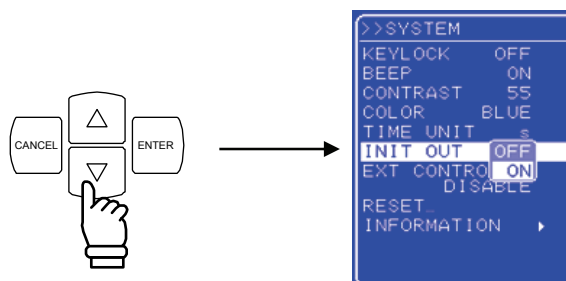

3. Press the  or  key to move the cursor to "ON" (when off) or to "OFF" (when on).





4. Press the  key to complete the setting. Press the  key to cancel the setting.

5.6.7 External control input enable/disable setting

External control input can be set as enabled or disabled. However, the APS-1102 status will be output even when external control input is set as disabled.

☞ See “4.5 Control Using External Control I/O Connector”, for details of external control input.

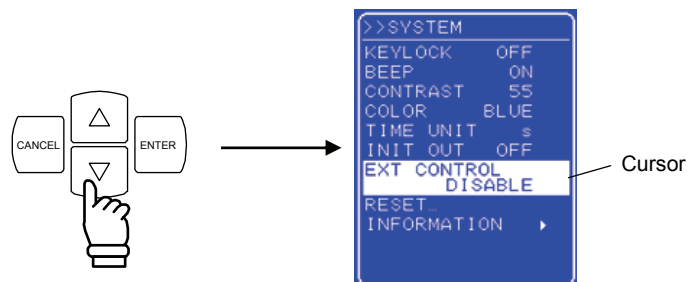

■ Operation steps

1. Press the  or  key to move the cursor to “EXT CONTROL”.



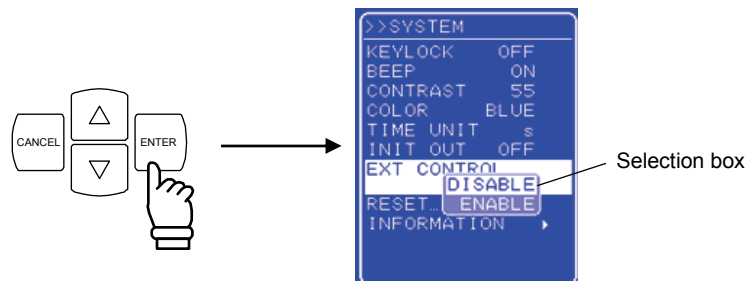

2. Press the  key to display the selection box.

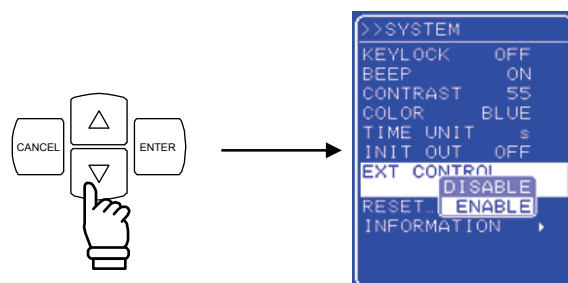

3. Press the  or  key to move the cursor to “ENABLE” or “DISABLE”.



4. Press the  key to complete the setting. Press the  key to cancel the setting.



5.6.8 Reset function

This function resets all basic settings to their initial (factory) settings.

The APS-1102 cannot be reset when output is on. Always turn output off before resetting the APS-1102.

☞ See “3.2 Display and Initial Settings at Power-on”, for description of the settings after a reset.

■ Operation steps

1. Press the  or  key to move the cursor to “RESET...”.

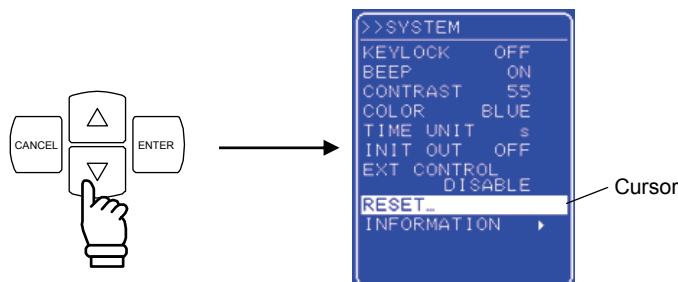

2. Press the  key to display the EXEC box .

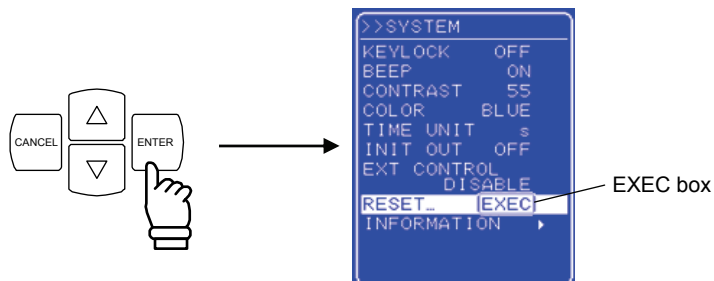

3. After selecting “EXEC”, press the  key to reset the APS-1102.

5.6.9 System information

Select “INFORMATION” in the “SYSTEM” screen to view system information such as the firmware version number.

☞ See “8.4 Checking the Version Number”, for description of the operation steps for viewing this version number.

6. USB INTERFACE

6.1	Setup for Use	6-2
6.2	Command List	6-3
6.3	Command Descriptions	6-9
6.3.1	Overview of Programming Language	6-9
6.3.2	Detailed command descriptions	6-14
6.4	Command Tree	6-42
6.5	Status System	6-43
6.5.1	Status byte	6-44
6.5.2	Standard event status	6-45
6.5.3	Operation status	6-47
6.5.4	Warning status	6-48
6.6	Error Message List	6-49
6.7	Programming Precautions	6-50

6.1 Setup for Use

The APS-1102 can be controlled under the USB Test and Measurement Class (USBTMC) standard. Almost all control functions can be operated from the control panel, and internal status information such as settings and error information can be read.

- The USB connector is located on the rear panel.
- Attach the accompanying ferrite core to the USB cable to reduce the leakage electric wave.
- The USB interface is designed for use in a relatively favorable environment. Consequently, it should not be used in environment with a lot of power source fluctuation or electrical noise.

Install a USBTMC class driver in the controlling computer, and then connect a commercial (off-the-shelf) USB cable. The installation file for the driver can be downloaded from National Instruments Corporation's web site. The operation steps for installing the driver are described below.

■ Operation steps

1. Go to the National Instruments Corporation web site and search for the VISA Run-time Engine page, or select "VISA driver downloads" at the following URL.
<http://www.ni.com/support/visa/>
2. Download the VISA Run-time Engine from the VISA Run-time Engine page. (User registration is required.) Be sure to download VISA Run-time Engine Ver. 3.3 or a later version.
3. The downloaded file is a self-extracting file. Install the extracted file.
4. Once installation is successfully completed, the USBTMC class driver is installed.

For details, see National Instruments Corporation's web site at www.ni.com.

6.2 Command List

The APS-1102 command list is shown in **Table 6-1** to **Table 6-9** and IEEE488.2 (SCPI) common commands supported by the APS-1102 are listed in **Table 6-10**.

The symbols used in **Table 6-1** to **Table 6-10** are explained below. The lowercase letters in each keyword can be omitted.

- Square brackets indicate keywords that can be omitted. (Implicit keywords)
- A vertical bar (|) indicates that one of several keywords is selected.

Table 6-1. Command List (SOURce Subsystem)

Function	Command
Output average current limiter	[SOURce:]CURRent:LIMit:AVErage
Output peak current limiter (positive)	[SOURce:]CURRent:LIMit:PEAK:HIGH
Output peak current limiter (negative)	[SOURce:]CURRent:LIMit:PEAK:LOW
Output frequency	[SOURce:]FREQUency[:IMMediate]
Frequency upper limit setting limit	[SOURce:]FREQUency:LIMit:HIGH
Frequency lower limit setting limit	[SOURce:]FREQUency:LIMit:LOW
Output waveform	[SOURce:]FUNCTion[:SHAPE][:IMMediate]
Output mode	[SOURce:]MODE
Sync signal source (external synchronization mode)	[SOURce:]PHASe:CLOCK
Phase when output is started	[SOURce:]PHASe[:IMMediate]
Sequence status	[SOURce:]SEQUence:CONDition?
Step number during execution	[SOURce:]SEQUence:CSTep?
Maximum number of steps in sequence	[SOURce:]SEQUence:LEN?
SEQ: jump times in step specified by STEP	[SOURce:]SEQUence:COUNt?
Clear sequence memory	[SOURce:]SEQUence:DELEte
Step execution parameter	[SOURce:]SEQUence:EPARameter
Step transition parameter	[SOURce:]SEQUence:TPARameter
Target step number for sequence editing	[SOURce:]SEQUence:STEP
AC output voltage	[SOURce:]VOLTage[:LEVel][:IMMediate][:AMPLitude]
Output voltage upper limit setting limit	[SOURce:]VOLTage:LIMit:HIGH
Output voltage lower limit setting limit	[SOURce:]VOLTage:LIMit:LOW
DC output voltage (during AC+DC-INT, AC+DC-ADD, or AC+DC-SYNC mode)	[SOURce:]VOLTage:OFFSet[:IMMediate]
Output voltage range	[SOURce:]VOLTage:RANGe

Table 6-2. Command List (MEASure Subsystem)

Function	Command
Output current RMS value	MEASure[:SCALar]:CURRent[:AC]?
+ current peak value	MEASure[:SCALar]:CURRent:HIGH?
– current peak value	MEASure[:SCALar]:CURRent:LOW?
Output current peak value hold	MEASure[:SCALar]:CURRent:AMPLitude:MAX?
Output current peak value hold reset	MEASure[:SCALar]:CURRent:AMPLitude:RESet?
Output current average value	MEASure[:SCALar]:CURRent:AVErage?
Load crest factor	MEASure[:SCALar]:CURRent:CREStfactor?
Output harmonic current [Arms]	MEASure[:SCALar]:CURRent:HARMonic[:AMPLitude]?
Output harmonic current [%]	MEASure[:SCALar]:CURRent:HARMonic:RATio?
External input signal frequency	MEASure[:SCALar]:FREQuency?
Apparent power	MEASure[:SCALar]:POWer:AC:APParent?
Output power factor	MEASure[:SCALar]:POWer:AC:PFACtor?
Reactive power	MEASure[:SCALar]:POWer:AC:REACtive?
Effective power	MEASure[:SCALar]:POWer:AC[:REAL]?
Output voltage RMS value	MEASure[:SCALar]:VOLTagE[:AC]?
+ voltage peak value	MEASure[:SCALar]:VOLTagE:HIGH?
– voltage peak value	MEASure[:SCALar]:VOLTagE:LOW?
Output voltage average value	MEASure[:SCALar]:VOLTagE:AVErage?

Table 6-3. Command List (DISPlay Subsystem)

Function	Command
Select measurement display	DISPlay[:WINDow]:MEASure:MODE

Table 6-4. Command List (STATus Subsystem)

Function	Command
Operation condition register	STATus:OPERation:CONDition?
Operation event enable register	STATus:OPERation:ENABle
Operation event register	STATus:OPERation[:EVENT]?
Operation transition filter	STATus:OPERation:NTRansition
	STATus:OPERation:PTRansition
Warning event condition register	STATus:WARNing:CONDition?
Warning event enable register	STATus:WARNing:ENABle
Warning event register	STATus:WARNing[:EVENT]?
Warning event transition filter	STATus:WARNing:NTRansition
	STATus:WARNing:PTRansition

Table 6-5. Command List (OUTPut Subsystem)

Function	Command
Output on/off	OUTPut[:STATe]

Table 6-6. Command List (INPut Subsystem)

Function	Command
External input gain	INPut:GAIN

Table 6-7. Command List (TRACe Subsystem)

Function	Command
Arbitrary waveform name list	TRACe:CATalog?
Send/receive arbitrary waveform data	TRACe[:DATA]
Clear arbitrary waveform memory	TRACe:DELEte:[NAME]

Table 6-8. Command List (SYSTEM Subsystem)

Function	Command
Beep sound on/off	SYSTEM:BEEPer:STATe
External control input enable/disable	SYSTEM:CONFIgure:EXTIO
Error query	SYSTEM:ERRor?
Output at power-on	SYSTEM:PON[:OUTPut]
Time unit for sequence step execution	SYSTEM:TUNit
Clear warning	SYSTEM:WRELease

Table 6-9. Command List (PROGRAM Subsystem)

Function	Command
Sequence operation control	PROGrama[:SELEcted]:EXECute

Table 6-10. Common Command List (Common Commands and Queries)

Common Commands and Queries	Name	Function
*CLS	Clear command	Clears standard event register, etc.
*ESE	Standard event enable command	Sets standard event enable register.
*ESR?	Standard event register query	Queries standard event register.
*IDN?	Identification query	Queries device ID information.
*OPC	Operation complete command	When device operation is completed, the standard event register operation complete message (OPC) is generated.
*RCL	Recall command	Reads contents of specified setting memory.
*RST	Reset command	Executes device reset. * In this device, the processing that is performed is similar to initializing the setting memory.
*SAV	Store command	Saves contents of specified setting memory.
*SRE	Service request enable command	Queries settings in the service request enable register.
*STB?	Read status byte query	Queries status byte and master summary status bit.
*TST?	Self test query	Executes auto test of device and returns the results. * For this device, "0" is always returned.
*WAI	Wait to continue command	Sets device in wait mode until all operations are completed.

a) Input buffer

- The number of commands that can be sent at one time is limited by the input buffer capacity (10,000 characters).
- The transferred commands are first stored in the input buffer, then successively interpreted and executed.
- When commands are being interpreted and executed, an error occurs if an illegal command is found. That command and those following will not be executed.
- When command interpretation and execution are completed, the input buffer is cleared to enable input of more commands.

6.3 Command Descriptions

6.3.1 Overview of Programming Language

This products conforms to IEEE488.2 and SCPI (VERSION 1999.0).

a) SCPI

SCPI defines methods used for communications between computers and measuring instruments.

Refer to the following for general information on SCPI.

<http://www.scpiconsortium.org>

Standard Commands for Programmable Instruments (SCPI) VERSION 1999.0

b) SCPI data format

All command messages and acknowledge messages sent to the APS-1102 are in “ASCII” format.

Table 6-11. Numerical Value Data Format

Symbol	Data Format
<NR1>	Numerical values without a decimal point (decimal position is to the right of the smallest digit in value) Example: 273
<NR2>	Numerical value with explicit decimal point Example: .0273
<NR3>	Numerical value with explicit decimal point and exponent Example: 2.73E+2
<Bool>	Boolean value (logical value) Example: 0 1 or ON OFF

Table 6-12. Character Data Format

Symbol	Data Format
<CRD>	Character format Example: SIN
<SRD>	Character format with double quotations Example: “No error”

- **Binary block data format**

The binary block data format is shown in **Figure 6-1**.

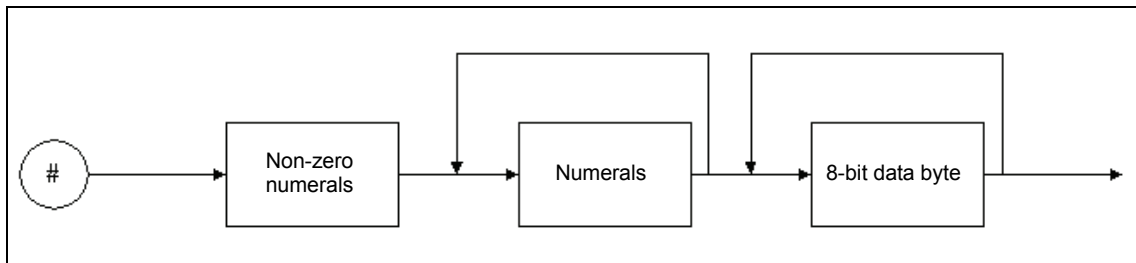

Figure 6-1. Binary Block Data

The “non-zero numeral” element value indicates the number of “numeral” elements that follow afterward. The “numeral” element value indicates the number of “8-bit data byte” elements that follow afterward.

For example, the format is as follows when sending four of the 8-bit data byte <DAB>.

#14<DAB><DAB><DAB><DAB>

c) Common commands

The common commands are used to provide overall control of device functions, such as device reset and status monitoring. These common commands have three-letter names that start with an asterisk.

d) Subsystem commands

Subsystem commands are commands used to execute the particular functions of devices.

Subsystem commands correspond to a measuring instrument internal function groups, with several sets divided into groups. Each subsystem command has a tree structure, and is defined using colons (:) as path separators.

1) SCPI command tree

Figure 6-2 shows a partial command tree of subsystem commands.

See **Figure 6-3** for an overview of the command tree.

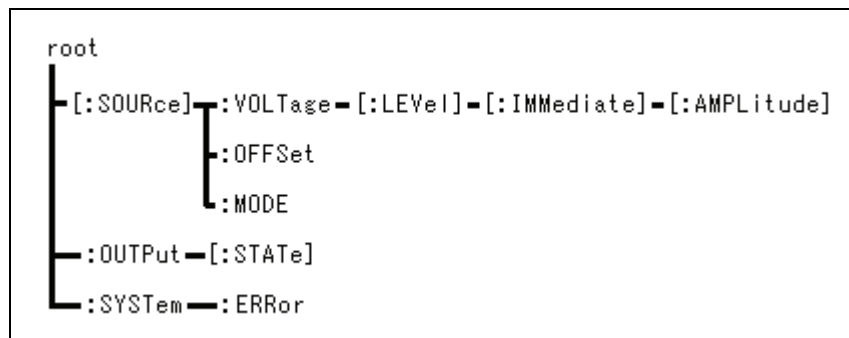

Figure 6-2. Partial Command Tree

- Root level

The command tree top level is the root. With SCPI, the current path is set to the root, as shown below.

- Immediately after the device power source goes on

- When the device receives a “root specifier”

The root specifier is a colon that is attached to the start of a command string to indicate that the current path is set to the root.

- When the device has received a “message terminator”

The message terminator is a line feed (LF) at the end of an SCPI message. The current path is returned to the root level when the device receives a message terminator.

- Current path

The current path is a command level within the command tree, which specifies the command level that will be searched first when the user sends a command.

2) Path separator

The path separator (:) separates the current keyword from the keyword at the next lower level. Each time a colon (:) is detected in a command string, the current path is moved one level downward.

When a colon appears at the start of a command string, it indicates that the current path is set to the root. This starting colon also can be freely omitted.

When a semicolon (;) is used to separate a command string, subsystem command on the same level can be accessed without changing the current path.

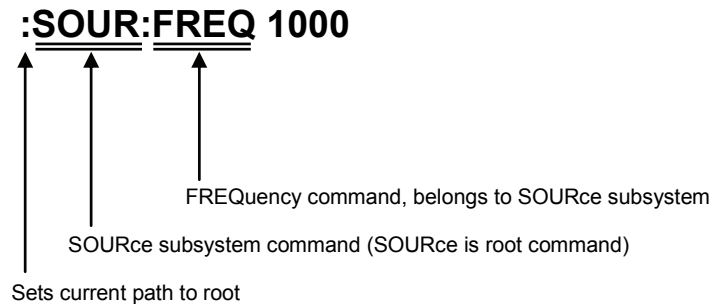

3) Abbreviation of command string

The command syntax enables each command (including certain parameters) to be written as a combination of uppercase and lowercase letters. The uppercase letters in the command can be used as an abbreviation of the command.

Moreover, this distinction between uppercase and lowercase letters in the command syntax exists just for the sake of convenience, since commands are not actually case sensitive. Note that abbreviation examples <1> to <3> below can be entered, but an error will occur if example <4> or <5> is entered.

Abbreviation examples for **SOURCE:FREQUENCY?**

- <1> "SOUR:FREQ?"
- <2> "SOURCE:FREQUENCY?"
- <3> "sour:freq?"
- × <4> "SOURC:FREQUE?"
- × <5> "sou:frequency?"

4) Implicit keywords

Any keyword that is enclosed by square brackets ([]) is an implicit keyword that can be omitted. Abbreviated command string examples <1> to <5> below all send the same setting to the target device.

Abbreviation examples for **[:SOURce]:VOLTage[:LEVel][:IMMEDIATE][:AMPLitude]**

- <1> “:SOUR:VOLT:LEV:IMM:AMPL 10VPP”
- <2> “:VOLT:LEV:IMM:AMPL 10VPP”
- <3> “:VOLT:LEV 10VPP”
- <4> “:VOLT 10VPP”
- <5> “:SOUR:VOLT:AMPL 10VPP”

6.3.2 Detailed command descriptions

The following describes various command functions and syntax.

a) Meanings of symbols

- Angle brackets (<>): Parameter symbols are enclosed in angle brackets. For example, <NR1> indicates the digital data format (NR1 type).
- A vertical bar (|) A parameter is used to alternative parameters. For example, “FIX|STEP” indicates that either “FIX” or “STEP” can be used as a parameter.
- Square brackets ([]) An option header is enclosed by square brackets. For example, “[SOURce:]LIST” indicates that “SOURce:” can be omitted.
- Bold (boldface) Boldface characters are used to emphasize a syntax string when a command is defined, such as **TRIGger:SOURCe<NRf>**.
- ▲ A triangular symbol is used to explicitly indicate that a space exists.

b) Remark

- Commands and queries are both included as APS-1102 commands, but for simplicity both are referred to as commands.
Any command that includes a question mark (?) with a keyword is a query.
- Headers are not applied to command reply messages.

c) SOURce subsystem

■ [SOURce:]CURRent:LIMit:AVErage

This sets the upper limit for the output average current. The output average current limiter setting ranges from 1.0 to 10.5 A (for 100 V range) or from 1.0 to 5.3 A (for 200 V range).

Syntax:	[SOURce:]CURRent:LIMit:AVErage▲<NR2>
Parameter:	1.0 to 10.5 (1.0 to 5.3)
Command example:	CURR:LIM:AVE 5
Query example:	CURR:LIM:AVE?
Response format:	<NR2>
Response example:	5.0

■ [SOURce:]CURRENT:LIMit:PEAK:HIGH

This sets the upper limit of the output peak current (positive polarity). The output peak current limiter (positive polarity) setting ranges from 10.0 to 42.0 A (for 100 V range) or from 5.0 to 21.0 A (for 200 V range).

Syntax:	[SOURce:]CURRENT:LIMit:PEAK:HIGH▲<NR2>
Parameters:	10.0 to 42.0 (5.0 to 21.0)
Command example:	CURR:LIM:PEAK:HIGH 10
Query example:	CURR:LIM:PEAK:HIGH?
Response format:	<NR2>
Response example:	10.0

■ [SOURce:]CURRENT:LIMit:PEAK:LOW

This sets the upper limit for output peak current (negative polarity). The output peak current limiter (negative polarity) setting ranges from -10.0 to -42.0 A (for 100 V range) or from -5.0 to -21.0 A (for 200 V range).

Syntax:	[SOURce:]CURRENT:LIMit:PEAK:LOW▲<NR2>
Parameters:	-10.0 to -42.0(-5.0 to -21.0)
Command example:	CURR:LIM:PEAK:LOW -10
Query example:	CURR:LIM:PEAK:LOW?
Response format:	<NR2>
Response example:	-10.0

■ [SOURce:]FREQUency[:IMMediate]

This sets the output frequency. When in AC-EXT/AC-SYNC/AC+DC-EXT/AC+DC-SYNC mode, the frequency cannot be set. ([3, "Invalid in this mode"] error occurs.)
The frequency setting ranges from 1.0 to 550.0 Hz.

Syntax:	[SOURce:]FREQUency[:IMMediate]▲<NR2>
Parameters:	1.0 to 550.0
Command example:	FREQ 50
Query example:	FREQ?
Response format:	<NR2>
Response example:	50.0

■ [SOURce:]FREQUency:LIMit:HIGH

This sets the upper limit of the frequency that can be set. However, a value that is at or below the currently set frequency cannot be set. ([5, “Out of Limiter”] error occurs.)

The limit value setting ranges from 1.0 to 550.0 Hz.

Syntax:	[SOURce:]FREQUency:LIMit:HIGH▲<NR2>
Parameters:	1.0 to 550.0
Command example:	FREQ:LIM:HIGH 550
Query example:	FREQ:LIM:HIGH?
Response format:	<NR2>
Response example:	550.0

■ [SOURce:]FREQUency:LIMit:LOW

This sets the lower limit of the frequency that can be set. However, a value that is at or above the currently set frequency cannot be set. ([5, “Out of Limiter”] error occurs.)

The limit value setting ranges from 1.0 to 550.0 Hz.

Syntax:	[SOURce:]FREQUency:LIMit:LOW▲<NR2>
Parameters:	1.0 to 550.0
Command example:	FREQ:LIM:LOW 50
Query example:	FREQ:LIM:LOW?
Response format:	<NR2>
Response example:	50.0

■ [SOURce:]FUNCtion[:SHAPe][:IMMediate]

This sets the output waveform. The output waveform setting is SIN/SQU/ARB1 to ARB16.

When in AC-EXT/AC+DC-EXT mode, the output waveform cannot be set. ([3, “Invalid in this mode”] error occurs.)

Syntax:	[SOURce:]FUNCtion[:SHAPe][:IMMediate]▲<CRD>
Parameters:	SIN/SQU/ARB1 to ARB16
Command example:	FUNC SIN
Query example:	FUNC?
Response format:	<CRD>
Response example:	SIN

■ [SOURCE:]MODE

This sets the output mode. There are eight output modes, each of them is a combination of one operation mode (AC or AC+DC) and one signal source mode, (INT, EXT, ADD, or SYNC).

Consequently, the output mode setting is AC-INT, AC-EXT, AC-ADD, AC-SYNC, AC+DC-INT, AC+DC-EXT, AC+DC-ADD, or AC+DC-SYNC.

However, when output is on, the output mode cannot be changed. ([1, “Invalid with output on”] error occurs.)

Syntax:	[SOURCE:]MODE▲<CRD>
Parameters:	AC-INT/AC-EXT/AC-ADD/AC-SYNC/ACDC-INT ACDC-EXT/ACDC-ADD/ACDC-SYNC
Command example:	MODE ACDC-INT
Query example:	MODE?
Response format:	<CRD>
Response example:	ACDC-INT

■ [SOURCE:]PHASE:CLOCK

This sets the sync signal source in the external synchronization mode (AC-SYNC or AC+DC-SYNC). The sync signal source setting is either LINE (line synchronization) or EXT (external synchronization). However, when output is on, the sync signal source cannot be changed. ([1, “Invalid with output on”] error occurs.)

Unless the mode is AC-SYNC or AC+DC-SYNC mode, the sync signal source setting cannot be set. ([3, “Invalid in this mode”] error occurs.)

Syntax:	[SOURCE:]PHASE:CLOCK▲<CRD>
Parameters:	LINE/EXT
Command example:	PHAS:CLOC EXT
Query example:	PHAS:CLOC?
Response format:	<CRD>
Response example:	EXT

■ [SOURCE:]PHASE[:IMMEDIATE]

This sets the phase at the start of output. The phase setting range is 0.0 to 359.9°. However, when output is on, the phase setting cannot be changed. ([1, “Invalid with output on”] error occurs.)

When in AC-EXT or AC+DC-EXT mode, the output waveform setting cannot be set. ([3, “Invalid in this mode”] error occurs.)

Syntax:	[SOURCE:]PHASE[:IMMEDIATE]▲<NR2>
Parameters:	0.0 to 359.9
Command example:	PHAS 90
Query example:	PHAS?
Response format:	<NR2>
Response example:	90.0

■ [SOURCE:]SEQUENCE:CONDITION?

This returns the sequence status. The response message is 0 (Idle mode), 1 (Run mode), or 2 (Hold mode).

Syntax:	[SOURCE:]SEQUENCE:CONDITION?
Parameters:	None
Query example:	SEQ:COND?
Response format:	<NR1>
Response example:	0

■ [SOURCE:]SEQUENCE:CSTEP?

This returns the step number being executed. The response ranges from -1 and 1 to 255. -1 is returned in the idle mode.

Syntax:	[SOURCE:]SEQUENCE:CSTEP?
Parameters:	None
Query example:	SEQ:CST?
Response format:	<NR1>
Response example:	2

■ [SOURCE:]SEQUENCE:LEN?

This returns the maximum number of sequence steps. 255 is always returned.

Syntax:	[SOURCE:]SEQUENCE:LEN?
Parameters:	None
Query example:	SEQ:LEN?
Response format:	<NR1>
Response example:	255

■ **[SOURce:]SEQuence:COUnT?**

This returns the jump times of the step specified by SEQ:STEP. The step jump times response ranges from -1 to 999. -1 is returned in the idle mode.

Syntax:	[SOURce:]SEQuence:COUnT?
Parameters:	None
Query example:	SEQ:COUN?
Response format:	<NR1>
Response example:	2

■ **[SOURce:]SEQuence:DELeTe**

This clears the sequence memory. When this command is executed, all sequence step settings are cleared.

However, the sequence memory contains a separate sequence for each operation mode (AC and AC+DC) and each output voltage range (100 V and 200 V), for a total of four combined sets.

When sequence memory is cleared by this command, only one of these four sets is selected as the memory.

When in AC-EXT, AC-SYNC, AC+DC-EXT, or AC+DC-SYNC mode, sequence memory cannot be cleared. ([3, “Invalid in this mode”] error occurs.)

Syntax:	[SOURce:]SEQuence:DELeTe▲<NR1>
Parameters:	1
Command example:	SEQ:DEL 1
Response format:	None
Response example:	None

■ **[SOURce:]SEQuence:EPARAmeter**

This sets the step execution parameters.

The target sequence step must be already set by the SEQ:STEP. (🔗 See “■[SOURce:]SEQuence:STEP” on page 6-22.)

However, the first parameter (DC voltage) and second parameter (DC voltage operation type) are valid only during AC+DC mode. When in AC mode, dummy values should be set. A “0” is returned for each of these parameters when in AC mode.

The unit of the third parameter varies depending on the waveform set by the seventh parameter. For the sine wave (SIN) and square wave (SQU), it is Vrms, and for the arbitrary waveform (ARB) it is Vp-p.

When in AC-EXT, AC-ADD, AC-SYNC, AC+DC-EXT, AC+DC-ADD, or AC+DC-SYNC mode, step execution parameters cannot be set or queried. ([3, “Invalid in this mode”] error occurs.)

Syntax:	[SOURce:]SEQuence:EPARAmeter▲<NR2>, <NR1>.....
First parameter (DC voltage [V])	

	Type	<NR2>
	Range	-200.0 to 200.0 (-400.0 to 400.0)
Second parameter (DC voltage operation type)		
	Type	<NR1>
	Range	0 (CONST), 1 (KEEP), or 2 (SWEEP)
Third parameter (AC voltage [Vrms]/[Vp-p])		
* The unit varies according to the waveform set by the seventh parameter.		
	Type	<NR2>
	Range	0.0 to 140.0 [Vrms] or 0.0 to 400.0 [Vp-p] (0.0 to 280.0 [Vrms] or 0.0 to 800.0 [Vp-p])
Fourth parameter (AC voltage operation type)		
	Type	<NR1>
	Range	0 (CONST), 1 (KEEP), or 2 (SWEEP)
Fifth parameter (frequency)		
	Type	<NR2>
	Range	1.0 to 550.0
Sixth parameter (frequency operation type)		
	Type	<NR1>
	Range	0 (CONST), 1 (KEEP), or 2 (SWEEP)
Seventh parameter (waveform)		
*The unit for the third parameter AC voltage varies depending on the seventh parameter setting.		
	Type	<NR1>
	Range	0 (SIN), 1 (SQU), or 2 to 17 (ARB1 to ARB16)
Eighth parameter (waveform operation type)		
	Type	<NR1>
	Range	0 (CONST) or 1 (KEEP)
Ninth parameter (start phase)		
	Type	<NR2>
	Range	0.0 to 359.9
10th parameter (start phase operation)		
	Type	<NR1>
	Range	0 (CONST) or 1 (KEEP)
11th parameter (step synchronized output)		
	Type	<NR1>
	Range	0 (00), 1 (01), 2 (10), or 3 (11)
12th parameter (step synchronized output operation type)		
	Type	<NR1>
	Range	0 (CONST) or 1 (KEEP)
Command example: SEQ:EPAR 0, 0, 100.0, 0, 50.0, 0, 1, 0, 90.0, 0, 0, 0		
Query example: SEQ:EPAR?		
Response example: 0, 0, 100.0, 0, 50.0, 0, 1, 0, 90.0, 0, 0, 0		

■ [SOURce:]SEQuence:TPARAmeter

This sets the step transition parameters.

The target sequence step must be set in advance by the SEQ:STEP. (See “■[SOURce:]SEQuence:STEP” on page 6-22.)

Use SYST:TUN (See “■ SYSTEM:TUNit” on page 6-36) in advance to set the unit for the sequence step execution time or query the unit.

When in AC-EXT, AC-SYNC, AC+DC-EXT, or AC+DC-SYNC mode, the step transition parameter cannot be set. ([3, “Invalid in this mode”] error occurs.)

Syntax: **[SOURce:]SEQuence:TPARAmeter▲<NR2>, <NR1>.....**

First parameter (step time [s]/[ms])

Type	<NR2>
Range	0.0001 to 999.9999 [s] 0.1 to 999999.9 [ms]

Second parameter (step end phase setting mode)

Type	<NR1>
Range	0 (disable) or 1 (enable)

Third parameter (step end phase [°])

Type	<NR2>
Range	0.0 to 359.9

Fourth parameter (step termination)

Type	<NR1>
Range	0 (continue), 1 (end), or 2 (hold)

Fifth parameter (jump step number)

Type	<NR1>
Range	0 (next step), 1 to 255

Sixth parameter (jump times)

Type	<NR1>
Range	0 (unlimited times), 1 to 999

Seventh parameter (branch 0)

Type	<NR1>
Range	0 (disabled), 1 to 999

Eighth parameter (branch 1)

Type	<NR1>
Range	0 (disabled), 1 to 999

Command example: SEQ:TPAR 2, 1, 180, 0, 0, 1, 0, 0

Query example: SEQ:TPAR?

Response example: 2, 1, 180, 0, 0, 1, 0, 0

■ [SOURce:]SEQuence:STEP

Specifies the target step number for sequence editing. The step number specification ranges from 1 to 255.

Syntax:	[SOURce:]SEQuence:STEP▲<NR1>
Parameters:	1 to 255
Command example:	SEQ:STEP 1
Query example:	SEQ:STEP?
Response format:	<NR1>
Response example:	1

■ [SOURce:]VOLTage[:LEVel][:IMMediate][:AMPLitude]

AC output voltage is set using the Vrms unit (when the waveform is SIN or SQU) or the Vp-p unit (when the waveform is ARB). For the 100 V range, output voltage setting ranges from 0.0 to 140.0 Vrms or from 0.0 to 400.0 Vp-p, and for the 200 V range, it ranges from 0.0 to 280.0 Vrms or from 0.0 to 800.0 Vp-p.

When in AC-EXT or AC+DC-EXT mode, the output AC voltage cannot be set or queried. ([3, “Invalid in this mode”] error occurs.)

Syntax:	[SOURce:]VOLTage[:LEVel][:IMMediate][:AMPLitude]▲<NR2>
Parameters:	0.0 to 140.0/0.0 to 400.0 (0.0 to 280.0/0.0 to 800.0)
Command example:	VOLT 100
Query example:	VOLT?
Response format:	<NR2>
Response example:	100.0

■ [SOURce:]VOLTage:LIMit:HIGH

This sets the upper limit of the output voltage that can be set. However, a value that is at or below the currently set cannot be specified. ([5, “Out of Limiter”] error occurs.)

For the 100 V range, the limit value setting ranges from 5.0 to 200.0 V, and for the 200 V range, it ranges from 10.0 to 400.0 V.

Syntax:	[SOURce:]VOLTage:LIMit:HIGH▲<NR2>
Parameters:	5.0 to 200.0 (10.0 to 400.0)
Command example:	VOLT:LIM:HIGH 200
Query example:	VOLT:LIM:HIGH?
Response format:	<NR2>
Response example:	200.0

■ [SOURce:]VOLTage:LIMit:LOW

This sets the upper limit of the output voltage that can be set. However, a value that is at or below the currently set cannot be specified. ([5, “Out of Limiter”] error occurs.)

For the 100 V range, the limit value setting ranges from –200.0 to –5.0 V, and for the 200 V range, it ranges from –400.0 to –10.0 V.

Syntax:	[SOURce:]VOLTage:LIMit:LOW ▲<NR2>
Parameters:	–200.0 to –5.0 (–400.0 to –10.0)
Command example:	VOLT:LIM:LOW –200
Query example:	VOLT:LIM:LOW?
Response format:	<NR2>
Response example:	–200.0

■ [SOURce:]VOLTage:OFFSet[:IMMediate]

This sets the DC voltage when in AC+DC-INT, AC+DC-ADD, or AC+DC-SYNC mode. For the 100 V range, the DC output voltage setting ranges from –200.0 to 200.0 V, and for the 200 V range, it range, from –400.0 to 400.0 V.

The DC output voltage cannot be set unless the mode is AC+DC-INT, AC+DC-ADD, or AC+DC-SYNC mode. ([3, “Invalid in this mode”] error occurs.)

Syntax:	[SOURce:]VOLTage:OFFSet[:IMMediate]▲<NR2>
Parameters:	–200.0 to 200.0 (–400.0 to 400.0)
Command example:	VOLT:OFFS 10
Query example:	VOLT:OFFS?
Response format:	<NR2>
Response example:	10.0

■ [SOURce:]VOLTage:RANGe

This sets the output voltage range. The output voltage range setting is 100 V or 200 V.

However, when output is on, output voltage range cannot be changed. ([1, “Invalid with output on”] error occurs.)

Syntax:	[SOURce:]VOLTage:RANGe ▲<NR1>
Parameters:	100/200
Command example:	VOLT:RANG 100
Query example:	VOLT:RANG?
Response format:	<NR1>
Response example:	100

d) MEASure subsystem

■ MEASure[:SCALar]:CURRent[:AC]?

This returns the output current RMS value (AC+DC RMS value) in Arms units. The output current RMS value measurement full scale is ± 15.00 Arms. If the measured value exceeds the full scale, 99.99 Arms is returned as a measurement error.

Syntax:	MEASure[:SCALar]:CURRent[:AC]?
Parameters:	None
Query example:	MEAS:CURR?
Response format:	<NR2>
Response example:	12.85

■ MEASure[:SCALar]:CURRent:HIGH?

This returns the positive current peak value (AC+DC peak value) in Apk units. The positive current peak value measurement full scale is 45.0 Apk. If the measured value exceeds the full scale, 99.9 Apk is returned as a measurement error.

Syntax:	MEASure[:SCALar]:CURRent:HIGH?
Parameters:	None
Query example:	MEAS:CURR:HIGH?
Response format:	<NR2>
Response example:	25.9

■ MEASure[:SCALar]:CURRent:LOW?

This returns the negative current peak value (AC+DC peak value) in Apk units. The negative current peak value measurement full scale is -45.0 Apk. If the measured value exceeds the full scale, -99.9 Arms is returned as a measurement error.

Syntax:	MEASure[:SCALar]:CURRent:LOW?
Parameters:	None
Query example:	MEAS:CURR:HIGH?
Response format:	<NR2>
Response example:	25.9

■ MEASure[:SCALar]:CURRent:AMPLitude:MAX?

This returns the output current peak value (hold) in Apk units. The held output current peak value full scale is 45.0 Apk. If the measured value exceeds the full scale, 99.9 Arms is returned as a measurement error.

Syntax:	MEASure[:SCALar]:CURRent:AMPLitude:MAX?
Parameters:	None
Query example:	MEAS:CURR:AMPL:MAX?
Response format:	<NR2>
Response example:	26.5

■ MEASure[:SCALar]:CURRent:AMPLitude:RESet

This resets the stored output current peak value (hold) to 0 Apk.

Syntax:	MEASure[:SCALar]:CURRent:AMPLitude:RESet▲<NR1>
Parameters:	1
Command example:	MEAS:CURR:AMPL:RES 1
Response format:	None
Response example:	None

■ MEASure[:SCALar]:CURRent:AVErage?

This returns the output current average value (AC+DC average value) in A units. The output current average value measurement full scale is ±15.00 A. If the measured value exceeds the full scale, 99.99 A is returned as a measurement error.

Syntax:	MEASure[:SCALar]:CURRent:AVErage?
Parameters:	None
Query example:	MEAS:CURR:AMPL?
Response format:	<NR2>
Response example:	1.2

■ MEASure[:SCALar]:CURRent:CREStfactor?

This returns the output current crest factor. The crest factor measurement full scale is 50.00. If the measured value exceeds the full scale, 99.99 is returned as a measurement error.

The crest factor is calculated as “current peak value/current RMS value”.

Syntax:	MEASure[:SCALar]:CURRent:CREStfactor?
Parameters:	None
Query example:	MEAS:CURR:CRESt?
Response format:	<NR2>
Response example:	1.41

■ MEASure[:SCALar]:CURRent:HARMonic[:AMPLitude]?

This returns the harmonic current in Arms units within the specified harmonic order range. The harmonic current measurement full scale is 15.00 Arms. If the measured value exceeds the full scale, 99.99 Arms is returned as a measurement error.

However, when in AC-INT mode, if the frequency is neither 50 Hz nor 60 Hz, the harmonic current cannot be measured. ([3, “Invalid in this mode”] or [6, “Invalid in this frequency”] error occurs.)

Syntax:	MEASure[:SCALar]:CURRent:HARMonic[:AMPLitude]?▲ <NR1>
Parameters:	1 (first to 10th), 2 (11th to 20th), 3 (21st to 30th), and 4 (31st to 40th)
Query example:	MEAS:CURR:HARM? 1
Response format:	<NR2>
Response example:	2.24, 0.02, 0.01, 0.15, 0.06, 0.08, 0.01, 0.01, 0.02, 0.06

■ MEASure[:SCALar]:CURRent:HARMonic:RATio?

This returns the ratio (%) of the nth harmonic current to the fundamental wave current as 100%. The measurement range is 0.0 to 500.0%. When the measured value exceeds the measurement range, 999% is returned as a measurement error.

However, when in AC-INT mode, if the frequency is neither 50 Hz nor 60 Hz, the harmonic current cannot be measured. ([3, “Invalid in this mode”] or [6, “Invalid in this frequency”] error occurs.)

Syntax:	MEASure[:SCALar]:CURRent:HARMonic:RATio?▲<NR1>
Parameters:	1 (first to 10th), 2 (11th to 20th), 3 (21st to 30th), and 4 (31st to 40th)
Query example:	MEAS:CURR:HARM:RAT? 1
Response format:	<NR2>
Response example:	100.0, 0.1, 0.1, 0.1, 0.1, 0.1, 0.1, 0.1, 0.1, 0.1

■ MEASure[:SCALar]:FREQUency?

This returns the external sync signal frequency in Hz units. The external sync signal frequency measurement range is 38.0 to 525.0 Hz. If the measured value exceeds the full scale, 999.9 Hz is returned as a measurement error.

The frequency measurement can only be performed in external synchronization mode (AC-SYNC or AC+DC-SYNC). ([3, “Invalid in this mode”] error occurs.)

Syntax:	MEASure[:SCALar]:FREQUency?
Parameters:	None
Query example:	MEAS:FREQ?
Response format:	<NR2>
Response example:	50.4

■ MEASure[:SCALar]:POWER:AC:APParent?

This returns the apparent power in VA units. The apparent power measurement full scale is 1400 VA. If the measured value exceeds the full scale, 9999 VA is returned as a measurement error.

Syntax:	MEASure[:SCALar]:POWER:AC:APParent?
Parameters:	None
Query example:	MEAS:POW:AC:APP?
Response format:	<NR1>
Response example:	367

■ MEASure[:SCALar]:POWER:AC:PFACtor?

This returns the output power factor. The power factor measurement range is 0.00 to 1.00. When the measured value exceeds the measurement range, 9.99 is returned as a measurement error. The power factor is calculated as “effective power/apparent power”.

Syntax:	MEASure[:SCALar]:POWER:AC:PFACtor?
Parameters:	None
Query example:	MEAS:POW:AC:PFAC?
Response format:	<NR2>
Response example:	0.68

■ MEASure[:SCALar]:POWER:AC:REACtive?

This returns the reactive power in Var units. The reactive power measurement full scale is 1400 Var. If the measured value exceeds the full scale, 9999 Var is returned as a measurement error.

Syntax:	MEASure[:SCALar]:POWER:AC:REACtive?
Parameters:	None
Query example:	MEAS:POW:AC:REAC?
Response format:	<NR1>
Response example:	269

■ MEASure[:SCALar]:POWER:AC[:REAL]?

The effective power is returned in W units. The effective power measurement full scale is 1200 W. If the measured value exceeds the full scale, 9999 W is returned as a measurement error.

Syntax:	MEASure[:SCALar]:POWER:AC[:REAL]?
Parameters:	None
Query example:	MEAS:POW:AC?
Response format:	<NR1>
Response example:	249

■ MEASure[:SCALar]:VOLTage[:AC]?

This returns the output voltage RMS value (AC+DC RMS value) in Vrms units. The output voltage RMS value measurement full scale is 450.0 Vrms. If the measured value exceeds the full scale, 999.9 Vrms is returned as a measurement error.

Syntax:	MEASure[:SCALar]:VOLTage[:AC]?
Parameters:	None
Query example:	MEAS:VOLT?
Response format:	<NR2>
Response example:	100.4

■ MEASure[:SCALar]:VOLTage:HIGH?

This returns the positive voltage peak value (AC+DC peak value) in Vpk units. The positive voltage peak value measurement full scale is 450 Vpk. If the measured value exceeds the full scale, 999 Vpk is returned as a measurement error.

Syntax:	MEASure[:SCALar]:VOLTage:HIGH?
Parameters:	None
Query example:	MEAS:VOLT:HIGH?
Response format:	<NR1>
Response example:	100

■ MEASure[:SCALar]:VOLTage:LOW?

This returns the negative voltage peak value (AC+DC peak value) in Vpk units. The negative voltage peak value measurement full scale is -450 Vpk. If the measured value exceeds the full scale, -999 Vpk is returned as a measurement error.

Syntax:	MEASure[:SCALar]:VOLTage:LOW?
Parameters:	None
Query example:	MEAS:VOLT:LOW?
Response format:	<NR1>
Response example:	-99

■ MEASure[:SCALar]:VOLTage:AVErage?

This returns the output voltage average value (AC+DC average value) in V units. The output voltage average value measurement full scale is ± 450.0 V. If the measured value exceeds the full scale, 999.9 V is returned as a measurement error.

Syntax:	MEASure[:SCALar]:VOLTage:AVErage?
Parameters:	None
Query example:	MEAS:VOLT:AVE?
Response format:	<NR2>
Response example:	0.2

e) DISPlay subsystem

■ DISPlay[:WINDow]:MEASure:MODE

This selects the measurement display selection. The measurement display selection setting is RMS (RMS value), AVG (average DC), PEAK (peak value), and HC (harmonic current) 1 to 4. The relation between the harmonic current mode and the harmonic degree is as follows.

HC1 (1st to 10th)

HC2 (11th to 20th)

HC3 (21st to 30th)

HC4 (31st to 40th)

However, when in AC-INT mode, if the frequency is neither 50 Hz nor 60 Hz, the harmonic current cannot be measured. ([3, “Invalid in this mode”] or [6, “Invalid in this frequency”] error occurs.)

When the measurement display selection is HC1 to HC4, the device cannot accept other commands. ([4, “Under Busy State”] error occurs.)

Syntax:	DISPlay[:WINDow]:MEASure:MODE▲<CRD>
Parameters:	RMS/AVG/PEAK/HC1/HC2/HC3/HC4
Command example:	DISP:MEAS:MODE RMS
Query example:	DISP:MEAS:MODE?
Response format:	<NR1>
Response example:	RMS

f) STATus subsystem

■ **STATus:OPERation:CONDition?**

This returns the operation condition register (OPCR). The response ranges from 0 to 20482.

Syntax:	STATus:OPERation:CONDition?
Parameters:	None
Query example:	STAT:OPER:COND?
Response format:	<NR1>
Response example:	16384

■ **STATus:OPERation:ENABLE**

This sets the operation event enable register (OPEE). The setting ranges from 0 to 20482.

Syntax:	STATus:OPERation:ENABLE ▲<NR1>
Parameters:	0 to 20482
Command example:	STAT:OPER:ENAB 16384
Query example:	STAT:OPER:COND?
Response format:	<NR1>
Response example:	16384

■ **STATus:OPERation[:EVENT]?**

This returns the operation event register (OPER) value. The response ranges from 0 to 20482.

Syntax:	STATus:OPERation[:EVENT]?
Parameters:	None
Query example:	STAT:OPER?
Response format:	<NR1>
Response example:	16384

■ STATus:OPERation:NTRansition

STATus:OPERation:PTRansition

This sets the operation transition filter (OPTF). The setting ranges from 0 to 20482.

- When the NTR filter is set to 1, OPER is set to 1 when OPCR changes from 1 to 0.
- When the PTR filter is set to 1, OPER is set to 1 when OPCR changes from 0 to 1.
- When the NTR and PTR filters are both set to 1, OPER is set to 1 when OPCR changes.
- When the NTR and PTR filters are both set to 0, changes in OPCR are not propagated to OPER.

Syntax:	STATus:OPERation:NTRansition▲<NR1> STATus:OPERation:PTRansition▲<NR1>
Parameters:	0 to 20482
Command example:	STAT:OPER:NTR 16384 STAT:OPER:PTR 0
Query example:	STAT:OPER:NTR? STAT:OPER:PTR?
Response format:	<NR1>
Response example:	16384 (when NTR is queried) 0 (when PTR is queried)

■ STATus:WARNing:CONDition?

The warning condition register (WRCR) value is returned. The response ranges from 0 to 31999.

Syntax:	STATus:WARNing:CONDition?
Parameters:	None
Query example:	STAT:WARN:COND?
Response format:	<NR1>
Response example:	16384

■ **STATus:WARNing:ENABLE**

This sets the warning event enable register. The setting ranges from 0 to 31999.

Syntax:	STATus:WARNing:ENABLE▲<NR1>
Parameters:	0 to 31999
Command example:	STAT:WARN:ENAB 1
Query example:	STAT:WARN:ENAB?
Response format:	<NR1>
Response example:	1

■ **STATus:WARNing[:EVENT]?**

This returns the warning event register value. The response ranges from 0 to 31999.

Syntax:	STATus:WARNing[:EVENT]?
Parameters:	None
Query example:	STAT:WARN?
Response format:	<NR1>
Response example:	0

■ **STATus:WARNing:NTRansition**

STATus:WARNing:PTRansition

This sets the warning transition filter (WRTF). The setting ranges from 0 to 31999.

- When the NTR filter is set to 1, WRER is set to 1 when WRCR changes from 1 to 0.
- When the PTR filter is set to 1, WRER is set to 1 when WRCR changes from 0 to 1.
- When the NTR and PTR filters are set to 1, WRER is set to 1 when WRCR changes.
- When the NTR and PTR filters are set to 0, changes in WRCR are not propagated to WRER.

Syntax:	STATus:WARNing:NTRansition▲<NR1> STATus:WARNing:PTRansition▲<NR1>
Parameters:	0 to 31999
Command example:	STAT:WARN:NTR 16384 STAT:WARN:PTR 0
Query example:	STAT:WARN:NTR? STAT:WARN:PTR?
Response format:	<NR1>
Response example:	16384 0

g) **OUTPut subsystem**■ **OUTPut[:STATe]**

This controls on/off settings of the output relay.

Syntax:	OUTPut[:STATe]▲<bool>
Parameters:	OFF 0 / ON 1
Command example:	OUTP ON
Query example:	OUTP?
Response format:	<NR1>
Response example:	1

h) **INPut subsystem**■ **INPut:GAIN**

This sets the external input gain used in the external mode (AC-EXT or AC+DC-EXT) and internal + external mode (AC-ADD or AC+DC-ADD). For the 100 V range, the external input gain setting ranges from 0.0 to 200.0 and for the 200 V range, it ranges from 0.0 to 400.0.

When in AC-EXT, AC-ADD, AC+DC-EXT, or AC+DC-ADD mode, the output waveform setting cannot be made. ([3, “Invalid in this mode”] error occurs.)

Syntax:	INPut:GAIN▲<NR2>
Parameters:	0.0 to 200.0 (0.0 to 400.0)
Command example:	INP:GAIN 10.0
Query example:	INP:GAIN?
Response format:	<NR2>
Response example:	10.0

i) TRACe subsystem

■ TRACe:CATalog?

This returns a list of defined waveform names. This command returns a list of all waveform names that can be selected by the user.

Syntax:	TRACe:CATalog?
Parameters:	None
Query example:	TRAC:CAT?
Response format:	<CRD>[, <CRD>]
Response example:	SIN, SQU, ARB1, ARB2, ARB3, ARB4, ARB5, ARB6, ARB7, ARB8, ARB9, ARB10, ARB11, ARB12, ARB13, ARB14, ARB15, ARB16

■ TRACe[:DATA]

This sends or receives arbitrary waveforms. When a waveform name (ARB1 to ARB16) is selected as the first parameter, the subsequent parameters are used to send 2 bytes × 4096 words (= 8192 bytes) of waveform data in big endian order (one word of waveform data is sent in 2's complement format, higher byte first and then lower byte). As in the command example, everything from the command to the data should be sent at one time.

However, the waveform data must be 4096 words.

The effective range for waveform data is -16384 to 16383. If a value of -16384 or below is input, it is returned as -16384. If a value of 16383 or above is input, it is recognized as 16383.

Syntax:	TRACe[:DATA]▲<CRD>, <Binary Block Data>	
First parameter (waveform name)	Type	<CRD>
	Range	ARB1 to ARB16
Second parameter and afterward (binary block data)	Configuration	#48192<DAB><DAB><DAB><DAB>...
Command example:	TRAC ARB1, #48192<DAB><DAB><DAB><DAB>...	
Query example:	TRAC? ARB1	
Response format:	<Binary Block Data>	
Response example:	#48192<DAB><DAB><DAB><DAB>...	

■ TRACe:DELEte[:NAME]

This clears the specified arbitrary waveform memory. When this command is executed, a sine wave is written to ARB1 to ARB8, a square wave is written to ARB9 to ARB12, and a triangle wave is written to ARB13 to ARB16.

However, when output is on, the arbitrary waveform memory cannot be cleared. ([1, “Invalid with output on”] error occurs.)

Syntax:	TRACe:DELEte[:NAME]▲<CRD>
Parameters:	ARB1 to ARB16
Command example:	TRAC:DEL ARB1
Response format:	None
Response example:	None

j) SYSTem subsystem

■ SYSTem:BEEPer:STATe

This controls the beep on/off setting. When the beep sound is enabled, beeps accompanying cursor operations become enabled, and an operation error or a protected operation will be notified with a beep.

Syntax:	SYSTem:BEEPer:STATe▲<bool>
Parameters:	OFF 0 / ON 1
Command example:	SYST:BEEP:STATe ON
Query example:	SYST:BEEP:STATe?
Response format:	<NR1>
Response example:	1

■ SYSTem:CONFIgure:EXTIO

This controls the external control input enable/disable setting.

Syntax:	SYSTem:CONFIgure:EXTIO▲<bool>
Parameters:	OFF 0 / ON 1
Command example:	SYST:CONF:EXTIO ON
Query example:	SYST:CONF:EXTIO?
Response format:	<NR1>
Response example:	1

■ **SYSTem:ERRor?**

This reads one error from the error queue (FIFO), and clears the read error in the error queue. The maximum number of errors that can be held in the error queue is 20. If 21 or more errors occur, [-350, “Too Many Errors”] is inserted as the 20th error.

Syntax:	SYSTem:ERRor?
Parameters:	None
Query example:	SYST:ERR?
Response format:	<NR1>,<SRD>
Response example:	0, “No error”

■ **SYSTem:PON[:OUTPut]**

This sets the output status at power-on. When the output status is on at power-on, the output turns on after the start-up and its display finishes.

However, if the system is restarted after a problem has been detected and the system has been locked, it will be started with output off regardless of this setting.

Syntax:	SYSTem:PON[:OUTPut]▲<bool>
Parameters:	OFF 0 / ON 1
Command example:	SYST:PON OFF
Query example:	SYST:PON?
Response format:	<NR1>
Response example:	0

■ **SYSTem:TUNit**

This sets the sequence step execution time unit as s or ms.

Syntax:	SYSTem:TUNit▲<NR1>
Parameters:	0 (s) / 1 (ms)
Command example:	SYST:TUN 0
Query example:	SYST:TUN?
Response example:	0

■ SYSTEM:WRELease

This clears a warning. When a warning is cleared, the SET screen is displayed and key input is enabled. In order for the warning to be cleared, it is necessary that all the factors of the warning has been removed and it is ready to be cleared.

(If no warning has occurred, or if a warning has occurred but the device is not ready to cancel the warning, [-200, "Execution error"] error occurs.)

Syntax:	SYSTEM:WRELease▲<NR1>
Parameters:	1
Command example:	SYST:WREL 1
Response format:	None
Response example:	None

(9) PROGRAM subsystem

■ PROGRAM[:SElected]:EXECute

This controls sequence operations. Control is performed using the STOP (stop), START (run), HOLD (hold), BRANCH0 (branch 0), or BRANCH1 (branch 1) parameter.

When in AC-EXT, AC-SYNC, AC+DC-EXT, or AC+DC-SYNC mode, sequences cannot be executed. ([3, "Invalid in this mode"] error occurs.)

When output is off, sequence execution is disabled. ([2, "Invalid with output off"] error occurs.)

Syntax:	PROGRAM[:SElected]:EXECute▲<CRD>
Parameters:	STOP / START / HOLD / BRANCH0 / BRANCH1
Command example:	PROG:EXEC START
Response format:	None
Response example:	None

I) Common commands

■ ***CLS**

This clears the following registers.

- Standard event register
- Operation event register
- Warning event register
- Status byte
- Error queue

Syntax:	*CLS
Parameters:	None
Command example:	*CLS
Response format:	None
Response example:	None

■ ***ESE**

This sets the standard event enable register. The setting ranges from 0 to 255.

Syntax:	*ESE▲<NR1>
Parameters:	0 to 255
Command example:	*ESE 255
Query example:	ESE?
Response format:	<NR1>
Response example:	255

■ ***ESR?**

This returns the standard event register value. When ESR reads the standard event register, all bits in the event register are cleared to 0. The response ranges from 0 to 255.

Syntax:	*ESR?
Parameters:	None
Query example:	*ESR?
Response format:	<NR1>
Response example:	128

■ *IDN?

This returns the model name, etc. The response message includes the “manufacturer, model name, serial number, and firmware version”.

Syntax:	*IDN?
Parameters:	None
Query example:	*IDN?
Response format:	<SRD>
Response example:	“GW Instek , APS-1102, 000001, Ver1.00”

■ *OPC

When all operations* have been completed, this sets the standard event register OPC bit (BIT0). *OPC? returns 1 when all operations have been completed. However, the standard event register OPC bit is not cleared to zero when *OPC? is executed.

Syntax:	*OPC
Parameters:	None
Command example:	*OPC
Query example:	*OPC?
Response format:	<NR1>
Response example:	1

■ *RCL

This recalls status information stored to memory by *SAV. The selection range for the recall memory is 1 to 30. However, recall is disabled when output is on. ([1, “Invalid with output on”] error occurs.)

Syntax:	*RCL▲<NR1>
Parameters:	1 to 30
Command example:	*RCL 1
Response format:	None
Response example:	None

■ *RST

This resets the device to its factory settings. However, reset cannot be executed when output is on. ([1, “Invalid with output on”] error occurs.)

Syntax:	*RST
Parameters:	None
Command example:	*RST
Response format:	None
Response example:	None

■ *SAV

This stores the current status information in memory. The memory storage ranges from 1 to 30.

Syntax:	*SAV▲<NR1>
Parameters:	1 to 30
Command example:	*SAV 1
Response format:	None
Response example:	None

■ *SRE

This sets the service request enable register. The setting ranges from 0 to 178.

Syntax:	*SRE▲<NR1>
Parameters:	0 to 178
Command example:	*SRE 178
Query example:	*SRE?
Response format:	<NR1>
Response example:	178

■ *STB?

This returns the status byte register value. The response ranges from 0 to 178.

Syntax:	*STB?
Parameters:	None
Query example:	*STB?
Response format:	<NR1>
Response example:	2

■ *TST?

This returns the self test results. In this device, “0” is always returned.

Syntax:	*TST?
Parameters:	None
Query example:	*TST?
Response format:	<NR1>
Response example:	0

■ *WAI

When all operations[※] are completed, the device is not able to execute any subsequent commands. This is to prohibit the device from executing any subsequent command until all the operations are completed.

Syntax:	*WAI
Parameters:	None
Command example:	*WAI
Response format:	None
Response example:	None

※ “Operations” means execution process of any commands in the following.

- Output mode setting [SOURce:]MODE
- Output range setting [SOURce:]VOLTage:RANGe
- Output relay control OUTPut[:STATe]
- Sequence execution PROGram[:SELEcted]:EXECute
- Memory recall RCL
- Device reset RST

6.5 Status System

The APS-1102 includes the minimum set of status groups defined by IEEE488.2. The APS-1102 status system is outlined below in **Figure 6-4**.

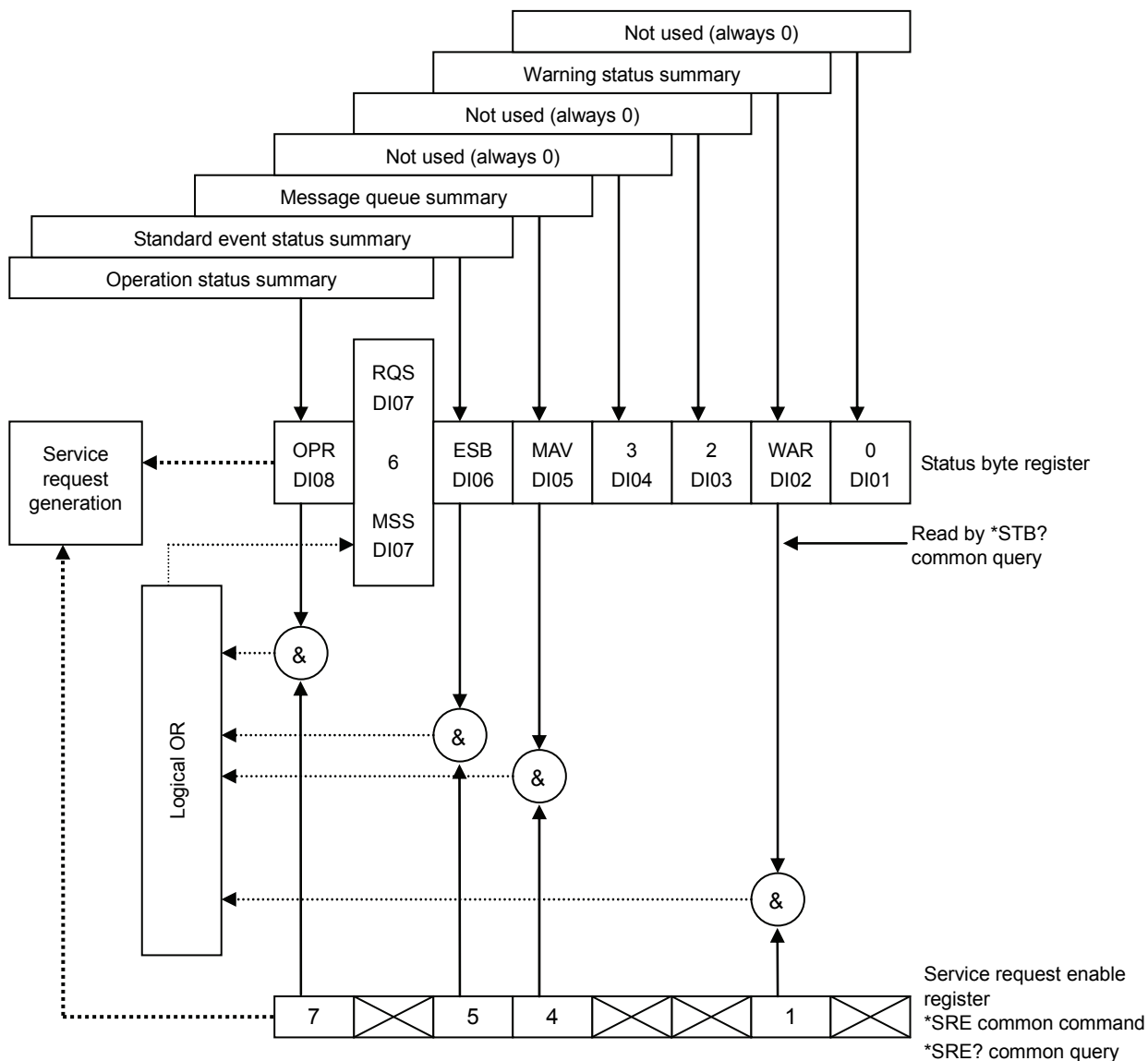

Figure 6-4. Status System

6.5.1 Status byte

The status byte register definitions are listed in **Table 6-13**. Bits in the status byte register become valid when 1 is set in the service request enable register, then the ORed result of the valid bits is taken to issue a service request.

A status byte can be read by the serial poll or an *STB? query.

Table 6-13. Status Byte Register Definitions

Bit	Weight	Description
OPR (7)	128	Operation status summary
RQS/MSS (6)	64	During the serial poll, this bit is defined as the RQS (Request Service) which indicates whether a service request has been issued to the controller by a device. This bit is cleared to zero when the serial poll is used. When using an *STB? query, this bit is defined as the MSS (Master Status Summary), and operates as the status byte summary bit. MSS is not cleared until there are no more enabling factors.
ESB (5)	32	The ESB (Event Status Bit) operates as the standard event status register summary bit. This bit is set (= 1) when any valid bit in the standard event status register is set (= 1), and is cleared to zero when all bits in that register are 0.
MAV (4)	16	The MAV (Message Available Bit) is set (= 1) when a response to a query is written to the corresponding response message queue and prepared for output. This bit is cleared to zero when the response message queue becomes empty.
3	8	Always 0 (not used)
2	4	Always 0 (not used)
WAR (1)	2	Warning status summary
0	1	Always 0 (not used)

a) Checking status when a query is issued

Once a query command has been issued, the answer to the query will be correctly received by receiving the response message by ordinary. There is no particular need to check the MAV bit in the status byte. To continue processing while checking the MAV bit, once the query command has been sent, confirm that the MAV bit = 1 in the status byte by serial poll, then read the response message and confirm that the MAV bit has been cleared to zero before proceeding to the next operation.

6.5.2 Standard event status

The structure of the standard event status register is shown in **Figure 6-5** below.

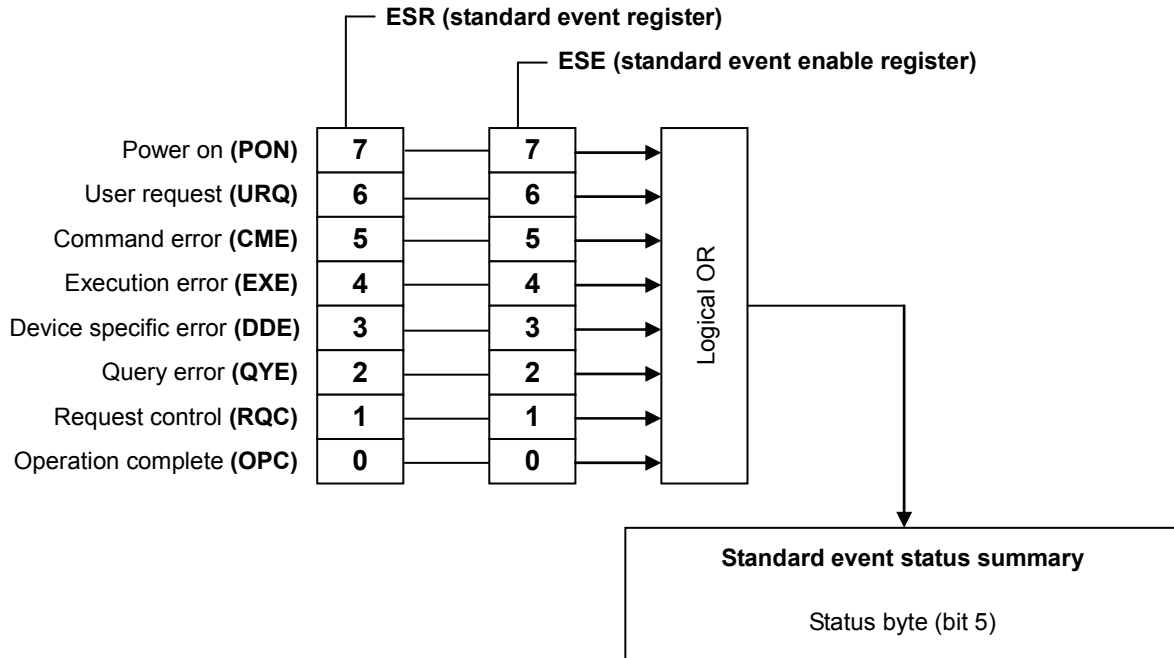

Figure 6-5. Standard Event Status Register

The definition of the standard event status register is listed in **Table 6-14**. Bits in the standard event status register become valid when 1 is set to the standard event status enable register, and the ORed result of the valid bits is reflected in the ESB bit of the status bit register.

The standard event status register can be read by an *ESR? query.

All of the bits are cleared when they are read by an *ESR? query, when a *CLS command is executed, or when the power is turned on again (except that the PON bit is set to 1 when the power is turned on again).

Table 6-14. Standard Event Status Register Definitions

Bit	Weight	Description
PON (7)	128	Power on bit 1 is set to this bit when the power is turned on. When this register is read, this bit is cleared to 0, and it remains 0 until the power is turned on again.
URQ (6)	64	User request bit Always 0 (not used)
CME (5)	32	Command error 1 is set to this bit when a syntax error occurs in the program code.
EXE (4)	16	Execution error 1 is set to this bit when a parameter is out of the setting range or when settings conflict.
DDE (3)	8	Device definition error Always 0 (not used)
QYE (2)	4	Query error 1 is set to this bit when there is no data in the buffer containing response messages when trying to read that buffer, or when the data in the buffer containing response messages has been lost.
RQC (1)	2	Request control Always 0 (not used) 1 is set to this bit when all processing of operation complete (OPC) commands has been completed. *In this device, this bit is always 0.
OPC (0)	1	Operation complete 1 is set to this bit when all processing of operation complete (OPC) commands has been completed.

6.5.3 Operation status

The structure of the operation status register is shown in **Figure 6-6** below.

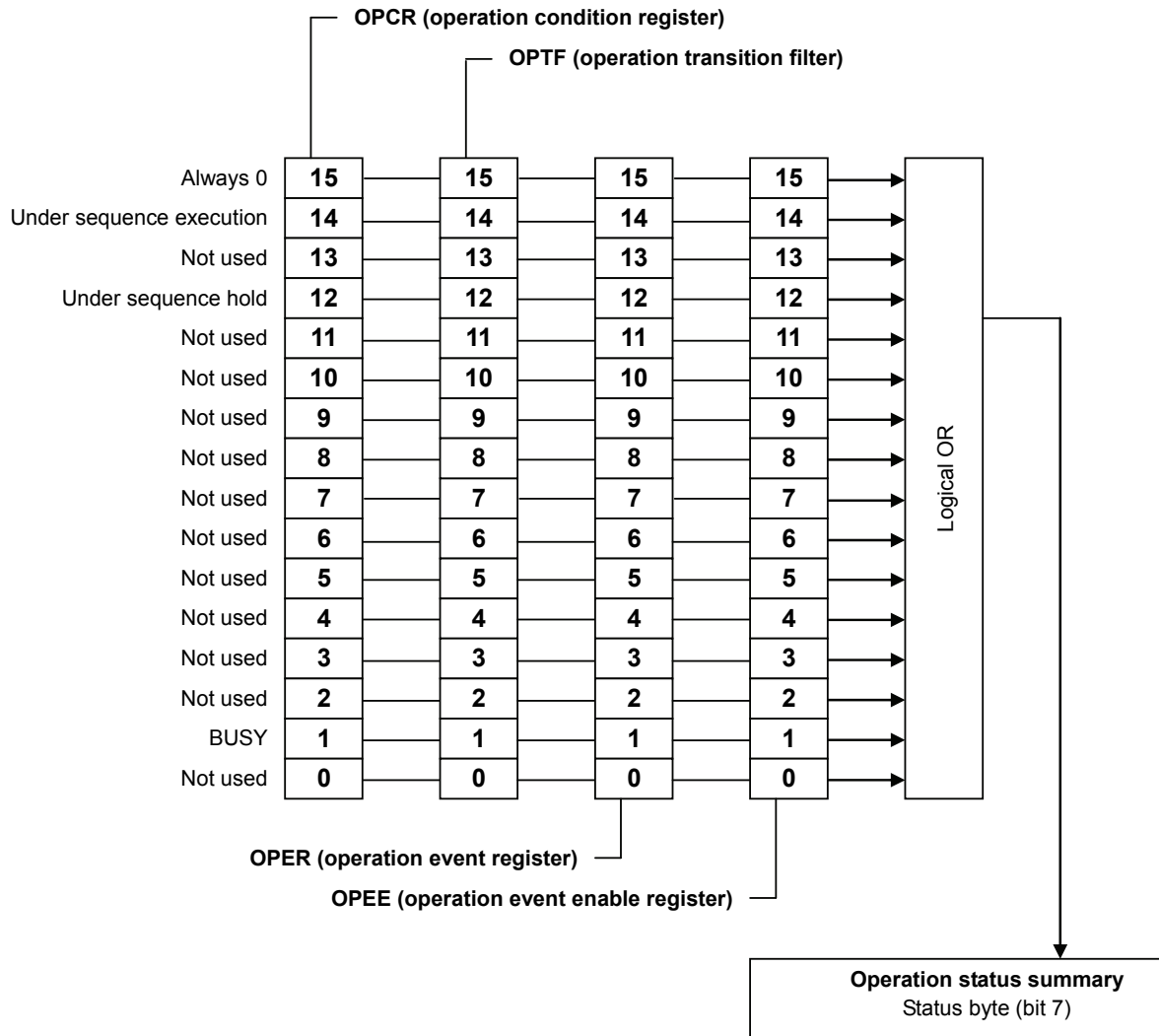

Figure 6-6. Operation Status

The transition filters convert conditions to events.

The transition filters include an NTransition filter and a PTransition filter. The settings and operations of these filters are described below.

- When the NTR filter is set to 1, OPER is set to 1 when OPCR changes from 1 to 0.
- When the PTR filter is set to 1, OPER is set to 1 when OPCR changes from 0 to 1.
- When the NTR and PTR filters are both set to 1, OPER is set to 1 when OPCR changes.
- When the NTR and PTR filters are both set to 0, changes in OPCR are not propagated to OPER.

6.5.4 Warning status

The structure of the warning status register is shown in **Figure 6-7** below.

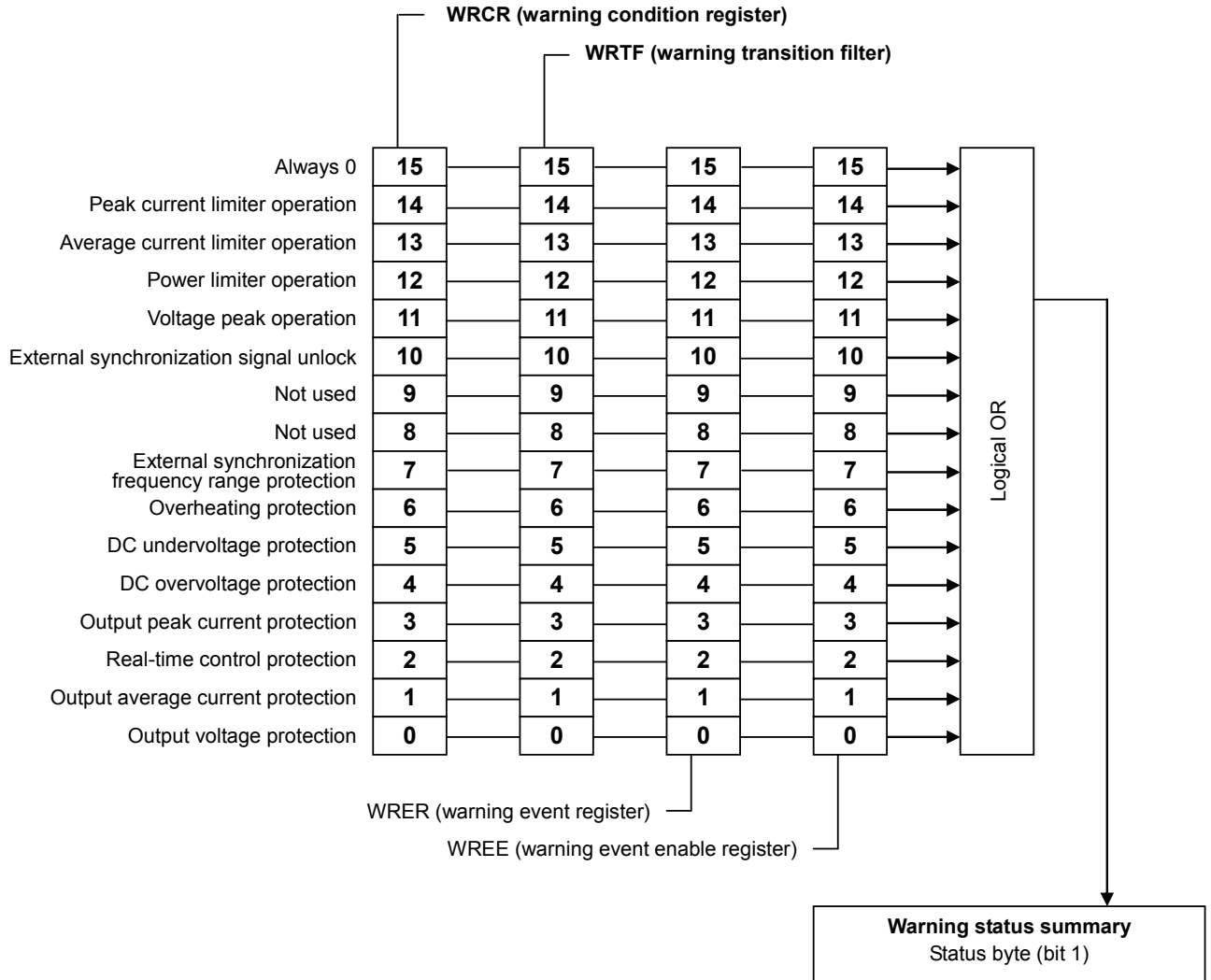

Figure 6-7. Warning Status

6.6 Error Message List

USB error messages are listed in **Table 6-15** below.

Table 6-15. USB Error Message List

No.	Message	Cause
0	“No error”	No error.
-100	“Command error”	Command was recognized as invalid due to any cause. (General command error)
-101	“Invalid character”	Command was recognized as invalid due to invalid characters (such as “VOLT&”) in command string.
-102	“Syntax error”	Command was recognized as invalid due to reception of undefined command or parameter.
-200	“Execution error”	Error occurred when executing the command due to any cause. (General execution error)
-222	“Data out of range”	Error occurred when executing the command due to out of range parameter.
-350	“Too Many Errors”	New errors cannot be retained due to error queue overflow.
1	“Invalid with output on”	Error occurred when executing the command because the output relay was on.
2	“Invalid with output off”	Error occurred when executing the command because the output relay was off.
3	“Invalid in this mode”	Error occurred when executing the command due to inappropriate output mode.
4	“Under Busy State”	Error occurred during execution of command due to busy device.
5	“Out of Limiter”	Error occurred during execution of command because limiter value was exceeded.
6	“Invalid in this frequency”	Error occurred when executing the command due to inappropriate oscillation frequency setting.
7	“Out of Input Signal frequency”	Error occurred when executing the command due to out of the external synchronization frequency range.
8	“Under Warning State”	Error occurred when executing the command because device was operating in protected mode.

6.7 Programming Precautions

a) **Arbitrary waveform data**

Arbitrary waveform data comprises a block of binary data. The preceding ASCII program message command field and the binary data block arbitrary waveform data should be transferred at the same time. Always transfer arbitrary waveform data in 4096-word (8192-byte) batches. If the data count is insufficient, an error may occur, in which case the correct waveforms cannot be output.

b) **Caution concerning commands issued via the USB interface**

When transferring commands, LF (0AH) must be appended at the end of the transmitted message string as the program message terminator. If a command is sent without appending this LF, operation will be incorrect.

7. TROUBLESHOOTING

7.1	Protection Function	7-2
7.2	Error Messages and Responses	7-4
7.2.1	Error at power-on.....	7-5
7.2.2	Protection function-related errors	7-6
7.2.3	Panel operation errors	7-8
7.2.4	Warning messages.....	7-10
7.2.5	USB-related external control errors	7-13
7.3	When Fault Is Suspected	7-13

7.1 Protection Function

The APS-1102 is equipped with a protection function that monitors the internal status and issues an error or warning when it detects the following types of abnormalities.

If the beep sound has been set to on, a beep will accompany the displayed error or warning. (A beep sounds whenever a protection function-related error occurs, regardless of the beep sound setting.)

a) Abnormal output

When output overvoltage or output overcurrent is detected, output will be set to off and the error message will be displayed.

b) Abnormal power source block

When an internal power source abnormality is detected, output will be set to off and the error or warning message will be displayed. If it is an error that occurred, all operations will become disabled except for the power shutdown operation.

c) Abnormal internal control

When an internal control abnormality is detected, output will be set to off and the error or warning message will be displayed. If it is an error that occurred, all operations will become disabled except for the power shutdown operation.

d) Abnormal internal temperature

When an abnormality is detected, output will be set to off when the warning message will be displayed.

 See “7.2.2 Protection function-related errors”, for description of error messages.

 See “7.2.4 Warning messages”, for description of warning messages.

 See “5.6.2 Beep sound”, for description of the beep sound.

The APS-1102 checks for errors in the order those listed in **Table 7-1** and only the message of the error detected first will be displayed.

Table 7-1. Protection Function

Protection	Action When Detected		Displayed Message
	Output off	System Lock	
Internal power source error	√	√	Internal power source error message ☞ See “7.2.2 Protection function-related errors”.
Internal communication error 1	√	√	Internal communication error message 1 ☞ See “7.2.2 Protection function-related errors”.
Internal communication error 2	√	√	Internal communication error message 2 ☞ See “7.2.2 Protection function-related errors”.
Control panel error	√	√	Control panel error message ☞ See “7.2.2 Protection function-related errors”.
Unexpected error	√	√	Unexpected error message ☞ See “7.2.2 Protection function-related errors”.
Output average current protection	√		Output average current protection message ☞ See “7.2.4 Warning messages”.
Output overvoltage protection	√		Output overvoltage protection message ☞ See “7.2.4 Warning messages”.
DC overvoltage protection	√		DC overvoltage protection message ☞ See “7.2.4 Warning messages”.
Output peak current protection	√		Output peak current protection message ☞ See “7.2.4 Warning messages”.
DC undervoltage protection	√	△ ^{Note}	DC undervoltage protection message ☞ See “7.2.4 Warning messages”.
Real-time control error	√		Real-time control warning message ☞ See “7.2.4 Warning messages”.
Abnormal internal temperature	√		Internal temperature warning message ☞ See “7.2.4 Warning messages”.
External sync signal frequency range error	√		External sync signal frequency range warning message ☞ See “7.2.4 Warning messages”.

Note System lock may occur.

7.2 Error Messages and Responses

The APS-1102 performs a self test at power-on, and outputs an error message if any abnormalities are detected. An error message is also displayed when a setting or operation is performed incorrectly or when an abnormality is detected in output or internally.

The contents of these error messages, their causes, and the required responses are described below.

7.2.1 Error at power-on

The APS-1102 performs the following fault checks at power-on.

If an error occurs, NG is displayed on the system check screen. Nothing is displayed when all check items are OK.

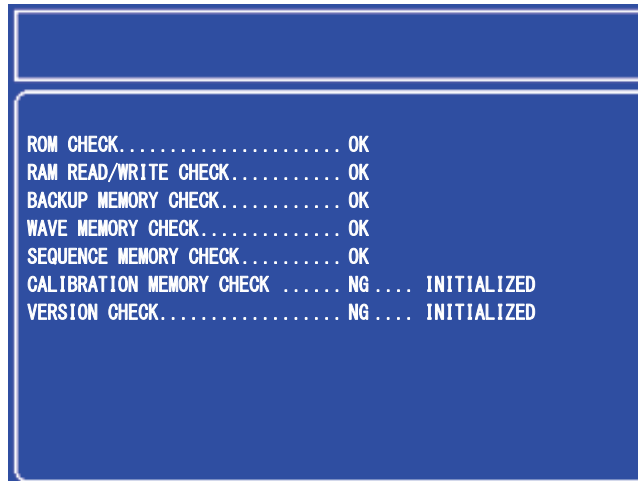

Figure 7-1. Screen Display When Self Fault Check Errors Have Occurred

Table 7-2 lists check items and processing when a fault is detected.

Table 7-2. Self Fault Check Messages

Message	Fault Check Item	Cause and Operation or Action Required When Fault Is Detected
ROM CHECK	ROM sum check	Message is displayed and the system will not start. The cause may be a faulty component. Contact Good Will or its representative.
RAM READ/WRITE CHECK	RAM read/write check	
BACKUP MEMORY CHECK	Backup memory sum check	Target memory is initialized, then the system is started. (☞ See “3.2 Display and Initial Settings at Power-on”.) If this occurs frequently, it may be due to deterioration of the backup battery. (☞ See “8.5 Backup Battery”.)
WAVE MEMORY CHECK	Waveform memory sum check	
SEQUENCE MEMORY CHECK	Sequence memory sum check	
CALIBRATION MEMORY CHECK	Calibration data check	The calibration value memory is initialized, then the system is started. In this case, the APS-1102 is started without calibrated values, so it may not provide the expected performance. Also, this may be due to a faulty component, in which case Good Will or its representative should be contacted.
VERSION CHECK	Version number check	Backup memory, sequence memory, and waveform memory are initialized, then the system is started.

7.2.2 Protection function-related errors

When a protection function-related error has occurred, an error message is displayed in the message window, and operation is stopped.

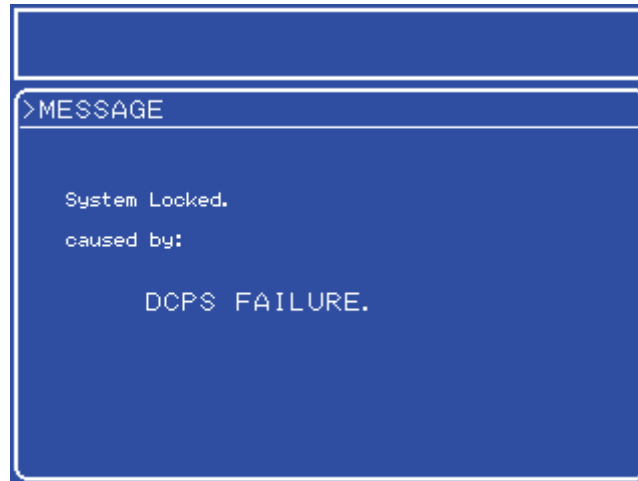

Figure 7-2. Screen Display When Protection Function-Related Error Has Occurred

When a protection function-related error message is displayed, turn off the power switch. (🔌 See “7.1

Protection Function".)

Table 7-3 lists error messages and actions when errors are detected.

Table 7-3. Protection Function-Related Errors

Error Message	Protection Item	Cause and Operation or Action Required When Fault Is Detected
System Locked. caused by: DCPS FAILURE	Internal power source error	Output is set to off and system lock status is set. Turn off the power switch. If the same protection error occurs again after the power is turned back on, contact Good Will or its representative.
System Locked. caused by: COMMUNICATION FAILURE 1	Internal communication error 1	
System Locked. caused by: COMMUNICATION FAILURE 2	Internal communication error 2	
System Locked. caused by: FRONT PANEL FAILURE	Control panel error	
System Locked. caused by: UNKNOWN ERROR	Unexpected error	

7.2.3 Panel operation errors

Panel operation error messages are displayed in the status window. The message box closes automatically after 1.5 seconds.

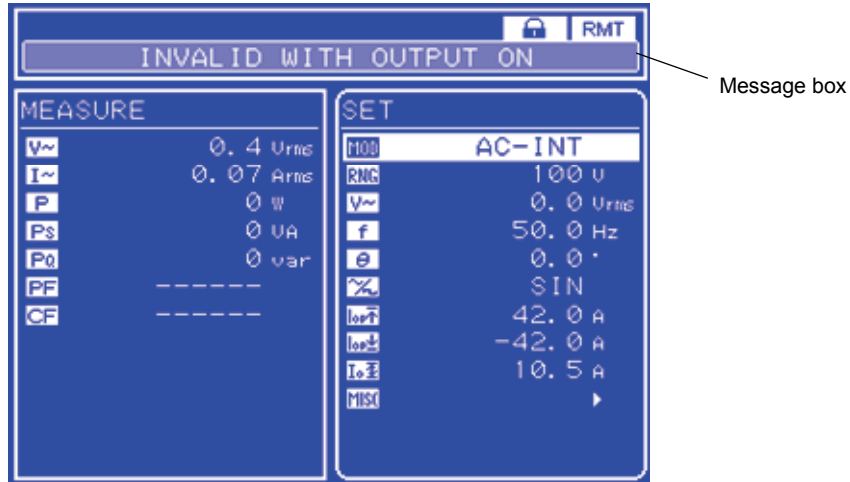









Figure 7-3. Screen Display When Panel Operation Error Has Occurred

Table 7-4. Panel Operation Errors (1/2)

Error Message	Cause and Action Required
OUT OF MEASURE RANGE	Measurement is out of range, cannot measure. (See “3.4.9 Using measurement functions”.)
INVALID IN THIS FREQUENCY	Frequency setting is not valid, so setting (execution) is disabled. Set 50 Hz or 60 Hz. (See “3.4.6 Setting output frequency”.)
OUT OF INPUT SIGNAL FREQUENCY	External sync signal frequency is outside of sync enabled range. (See “4.7 Synchronization of Output to External Signal”.)
OUT OF RANGE	USB parameter range check error. Set the parameter within the possible range of settings. (Remote mode only) (See “6.3.2 Detailed command descriptions”.)
INVALID WITH OUTPUT ON	Setting (execution) is invalid while output is on. Turn output off. (See “3.4.8 Output on/off”.)
INVALID WITH OUTPUT OFF	Setting (execution) is invalid while output is off. Turn output on. (See “3.4.8 Output on/off”.)
INVALID IN THIS MODE	Cannot set (execute) due to invalid output mode. Change the output mode. (See “3.4.2 Setting output mode”.)

Table 7-5. Panel Operation Errors (2/2)

Error Message	Cause and Action Required
UNDER BUSY STATE	Cannot set (execute) due to BUSY status. Wait until the BUSY display disappears, then try operation again. ( See “3.4.3 Setting output voltage range”.)
UNDER REMOTE STATE	Cannot set (execute) due to remote status. Set local mode. ( See “5.5.3 Remote”.)
UNDER LOCAL STATE	Cannot set (execute) due to local mode. (Remote mode only) ( See “4.5 Control Using External Control I/O Connector”.) ( See “6 USB INTERFACE”.)
UNDER KEYLOCK	Cannot set (execute) due to keylock status. Cancel keylock. ( See “5.6.1 Keylock”.)
OUT OF LIMITER	Cannot set (execute) because range limit is exceeded. (Remote mode only) ( See “4.5 Control Using External Control I/O Connector”.) ( See “6 USB INTERFACE”.)
COMMAND ERROR	This is the USB interface command error. Check the command. (Remote mode only) ( See “6.6 Error Message List”.)
EXECUTION ERROR	Execution errors other than the above.

7.2.4 Warning messages

When output is turned off due to an output error, internal temperature error, or external sync signal frequency out of range error, a warning is displayed in the message window. (🔔) **See “7.1**

Protection Function”.)

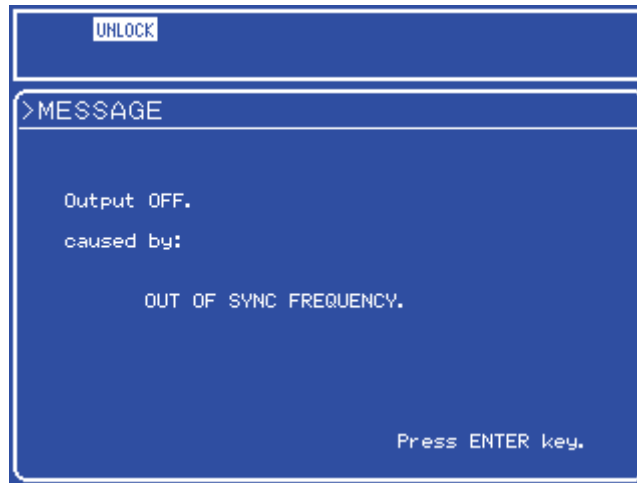

Figure 7-4. Screen Display When Warning Has Occurred

Until the warning has been canceled for the device, no key or command operations will be accepted. When the warning is canceled for the device, “Press ENTER key” is displayed on the warning screen. To close the warning screen, press the ENTER key or CANCEL key. If the “Press ENTER key.” message is not shown within 10 seconds, turn off the power and turn it on again.

Table 7-6 and **Table 7-7** describe these warning messages.

Table 7-6. Warning Messages (1/2)

Message	Cause and Action Required
Output OFF. caused by: OVER VOLTAGE	Output off due to the output overvoltage protection function. Press the ENTER key or CANCEL key. The error is cleared and the system becomes available. Check settings and load conditions before using.
Output OFF. caused by: OVER CURRENT	Output off due to the output average current protection function. Press the ENTER key or CANCEL key. The error is cleared and the system becomes available. Check settings and load conditions before using.

Table 7-7. Warning Messages (2/2)

Message	Cause and Action Required
Output OFF. caused by: OVER PEAK CURRENT	Output off due to the output peak current protection function. Press the ENTER key or CANCEL key. The error is cleared and the system becomes available. Check settings and load conditions before using.
Output OFF. caused by: OVER DC VOLTAGE	Output off due to the DC power source block overvoltage protection function. Press the ENTER key or CANCEL key. The error is cleared and the system becomes available. Check settings and load conditions before using.
Output OFF. caused by: UNDER DC VOLTAGE	Output off due to the DC power source block undervoltage protection function. Press the ENTER key or CANCEL key. The error is cleared and the system becomes available. Check settings and load conditions before using. The device may enter the error status and the system may be locked. In such a case, turn the power off. If a protection error is repeatedly detected after power-on, contact Good Will or an authorized distributor.
Output OFF. caused by: REALTIME CONTROL FAILURE	Output off due to the real-time control error function. Press the ENTER key or CANCEL key. The error is cleared and the system becomes available. Check settings and load conditions before using.
Output OFF. caused by: OVER TEMPERATURE	Output off due to the internal temperature error protection function. Press the ENTER key or CANCEL key. The error is cleared and the system becomes available. Check the ambient temperature and other installation conditions before using.
OUTPUT OFF caused by: OUT OF SYNC FREQUENCY	Output off due to the external sync signal frequency out of range function. Press the ENTER key or CANCEL key. The error is cleared and the system becomes available. Check the external sync signal source before using.

7.2.5 USB-related external control errors

Table 7-6 lists USB-related external control error messages.

Table 7-8. USB Error Message List

No.	Message Text	Cause
0	“No error”	No error.
-100	“Command error”	Command was recognized as invalid due to any cause. (General command error)
-101	“Invalid character”	Command was recognized as invalid due to invalid characters (such as “VOLT&”) in command string.
-102	“Syntax error”	Command was recognized as invalid due to reception of undefined command or parameter.
-200	“Execution error”	Error occurred when executing the command due to any cause. (General execution error)
-222	“Data out of range”	Error occurred when executing the command due to out of range parameter.
-350	“Too Many Errors”	New errors cannot be retained due to error queue overflow.
1	“Invalid with output on”	Error occurred when executing the command because the output relay was on.
2	“Invalid with output off”	Error occurred when executing the command because the output relay was off.
3	“Invalid in this mode”	Error occurred when executing the command due to inappropriate operation mode.
4	“Under Busy State”	Error occurred during execution of command due to busy device.
5	“Out of Limiter”	Error occurred during execution of command because limiter value was exceeded.
6	“Invalid in this frequency”	Error occurred when executing the command due to inappropriate oscillation frequency setting.
7	“Out of Input Signal frequency”	Error occurred when executing the command due to out of the external synchronization frequency range.
8	“Under Warning State”	Error occurred when executing the command because device was operating in protected mode.

7.3 When Fault Is Suspected

If a problem that might be due to a fault occurs when using the APS-1102, check the following table to determine whether the problem might be due to an operation, use method, connection error, etc.

If the problem is not covered by this table, leave the power off and contact Good Will or an authorized representative.

Table 7-9. When Fault Is Suspected (Problem when Switching Power on/off)

Symptom	Possible Cause	Required Action, etc.
Does not operate after turning on power switch.	Not connected to a commercial power source.	Make sure the power cord is firmly inserted into the outlet and the inlet (on rear panel of the APS-1102).
	Power source being used is outside the rated range.	Use a power source that is within the rated range.
	Internal fuse is broken.	Contact Good Will or its representative.
Does not stop immediately after turning off power switch.	This is not a failure. The device will stop automatically after the internal voltage has reached a safe level.	Please wait. It will stop in approximately five seconds.
LCD is blank. (Fan is operating.)	LCD has low contrast setting.	Increase the LCD contrast setting. To adjust the LCD contrast when the screen contents cannot be seen, press the ENTER key and CANCEL key at the same time. This sets the digit cursor to the 10's column.  See "5.6.3 LCD contrast adjustment".

Table 7-10. When Fault Is Suspected (Problem During Key Operation)

Symptom	Possible Cause	Required Action, etc.
Panel operation does not work.	Keylock has been set to on.	Turn off the keylock.  See "5.6.1 Keylock".
	Key or MODIFY dial has been degraded.	Contact Good Will or its representative for repairs.

Table 7-11. When Fault Is Suspected (Problem Related to Output Voltage or Output Voltage Range Setting)

Symptom	Possible Cause	Required Action, etc.
Output voltage range cannot be switched.	Fault in internal power source (internal power source error has occurred).	Turn power switch off. If the output voltage range cannot be switched after turning the power source back on, contact Good Will or its representative for repairs.
Cannot set output voltage.	External signal input mode has been set.	Output voltage cannot be set when the signal source mode is external signal input (EXT). Set the signal source mode to internal (INT) or internal + external (ADD) mode. See “3.4.2 Setting output mode”. See “5.3.1 Output mode setting”.
Set value differs from measured value.	Unnecessary items have been set (for example, AC has been set even though only DC output will be used).	Check the settings again. When using ADD mode, check both the external signal and external input gain. See “4.10 Adding External Signals and Internal Signals”. Also, check the selected measurement display items. See “5.5.6 Selection of measurement display (MEASURE)”.
	A low impedance load is being driven.	With a low resistance load, inductance load, or capacitive load, the measured value may be less than the value set for the limiter operation.

Table 7-12. When Fault Is Suspected (Problem Related to Frequency Setting)

Symptom	Possible Cause	Required Action, etc.
Output frequency cannot be set.	External signal input or external synchronization mode has been set.	Output frequency cannot be set when the signal source mode is external signal input (EXT) or external synchronization (SYNC). Set the signal source mode to internal (INT) or internal + external (ADD) mode. See “3.4.2 Setting output mode”. See “5.3.1 Output mode setting”.
Line synchronization cannot be set.	External synchronization mode has been set.	Set the signal source mode to external synchronization (SYNC), then set the external sync signal source to LINE. See “3.4.2 Setting output mode”. See “4.7.2 Line synchronization”. See “5.3.1 Output mode setting”.

Table 7-13. When Fault Is Suspected (Problem Related to Output Error)

Symptom	Possible Cause	Required Action, etc.
No output	Output voltage setting is “0”.	Check the output voltage setting. ☞ See “3.4.5 Setting output voltage”.
	Signal source is not connected.	When the signal source mode is external signal (EXT), connect the signal source to the external signal input terminal, then set a suitable external input gain. ☞ See “3.3.4 External signal input/external sync signal input terminal”. ☞ See “4.9 Amplification of External Signal”.
	External input gain is set to “0”.	
	Output on/off switch (OUTPUT) is not set to on.	Set the output on/off switch to on.
	Protection function-related error or warning message is displayed.	Output cannot be set to on when a protection function-related error or warning message is being displayed. See the error responses listed in “Table 7-3. Protection Function-Related Errors” and “Table 7-6. Warning Messages” and eliminate the cause of the error. When a protection function-related error message is being displayed, all key operations become invalid. Turn the power source switch off, then back on again.
Warning message is displayed.	Overload has occurred.	Connect a load that is within the maximum output range or lower the output level.
	Excessive signal level in signal generator	If the signal source is EXT or ADD, either reduce the connected signal output level or reduce the external input gain.
	Ambient temperature is too high.	Keep the ambient temperature during use at 40°C or below.
	Air filter is clogged.	Refer to “8.2 Routine Maintenance” and clean the air filter.
	Something is blocking the air flow near the air intake on the front panel or the air exhaust on the rear panel.	Make sure the APS-1102 complies with the installation requirements described in “2.2 Installation Environment”.

Table 7-14. When Fault Is Suspected (Problem Related to Measurement Functions)

Symptom	Possible Cause	Required Action, etc.
Measured value for voltage or current is not displayed correctly.	Selected display items are not appropriate.	For AC, select RMS. Displayed values will not be correct unless RMS is selected.
“----” is displayed.	Measurement is out of range. (Out of measurable range)	“----” is displayed when any of the measurement ranges set as described in “ 5.4 MEASURE Screen ” have been exceeded. Check the load conditions and set values.
Measured values are inconsistent.	Measurements are being taken in external mode (EXT).	When in external mode (EXT), the measurement cycle is fixed. If the external input signal frequency is known, change the output mode to ADD mode (AC-ADD or AC+DC-ADD), set the internal oscillator output voltage to “0”, and set the frequency as the external input frequency.
	Measurements are at low frequency (10 Hz or less).	When the frequency is lower than 10 Hz, the measurement cycle is fixed, so the measured values may become unstable.

Table 7-15. When Fault Is Suspected (Problem Related to Sequence Function)

Symptom	Possible Cause	Required Action, etc.
Sequence control does not work.	Output is off.	Set output to on.
When a sequence is completed, the setting differs from the final step.	When completed, the voltage or frequency is outside the setting range limit.	Setting range limit was not checked when programming the sequence. When the final step value is outside the setting range limit, it is forcibly changed to the lower limit value.

Table 7-16. When Fault Is Suspected (Problem Related to Memory Function)

Symptom	Possible Cause	Required Action, etc.
Memory recall does not work.	Output on/off switch (OUTPUT) is set to on.	When output is on, recall cannot operate. Set the output on/off switch to OFF.

Table 7-17. When Fault Is Suspected (Problem Related to Limiter Setting Range Limit)

Symptom	Possible Cause	Required Action, etc.
Output peak current limiter set value exceeds the output peak current limiter setting.	Overshoot current value is being measured.	The output peak current limiter may overshoot, depending on the load.  See “3.4.7 Using limiter functions”.

Table 7-18. When Fault Is Suspected (Other Problems)

Symptom	Possible Cause	Required Action, etc.
Transformer is used as the load, but current is abnormal, causing saturation.	When the APS-1102 output is set to AC mode, the electronic circuitry performs control so that abnormal DC voltage is not generated, but due to control limitation, the voltage cannot be reduced all the way to 0 V. Depending on the connected transformer, a slight DC voltage may be emitted, which applies DC excitation to the core, and abnormalities may occur in the transformer excitation current.	Set AC (AC) mode. When in AC-INT mode, the APS-1102 DC offset voltage is ± 50 mV or less (100 V range). or ± 100 mV or less (200 V range). When using this device with a connected transformer, consider the effects of these values.
Output overvoltage occurs when inductive load (transformer, etc.) is used.	Back emf was included by the operation of the peak current limiter.	Lower the peak current limiter settings (positive and negative).

8. MAINTENANCE

8.1	Introduction.....	8-2
8.2	Routine Maintenance	8-2
8.3	Storage, Repackaging, and Transport.....	8-4
8.4	Checking the Version Number.....	8-5
8.5	Backup Battery.....	8-7

8.1 Introduction

This chapter describes the following items.

- Caution points and storage methods for long periods of non-use
- Caution points for transport and when repackaging for transport

See “**2.4 Simple Operation Checks**”, for description of simple operation checks.

If these operation checks are not passed, request calibration and/or repair from Good Will or its representative.

8.2 Routine Maintenance

Be sure to install the APS-1102 in a location that meets the installation requirements.

 See “**2.2 Installation Environment**”, for description of the installation requirements.

a) When panel or case is dirty

Wipe clean with a soft cloth. For stubborn dirt, use a cloth that has been dipped in neutral detergent and then firmly wrung out.

Do not use a cloth treated with a volatile solvent, such as paint thinner or benzene, or a chemically treated cloth, which may cause discoloration or peeling of paint.

b) When fan filter is dirty

Two air filters are provided to filter out dust that gathers through the air inlets in the front panel. When too much dirt accumulates in the filters, it can clog them and reduce air flow, causing higher internal temperatures which can reduce reliability. Periodically check the condition of the air filters. The air filters should be cleaned about once a month, or whenever fine dust has accumulated in the filter.

To clear the air filters, rinse (with water, etc.) then dry them well. They should be completely dry when reinstalled.

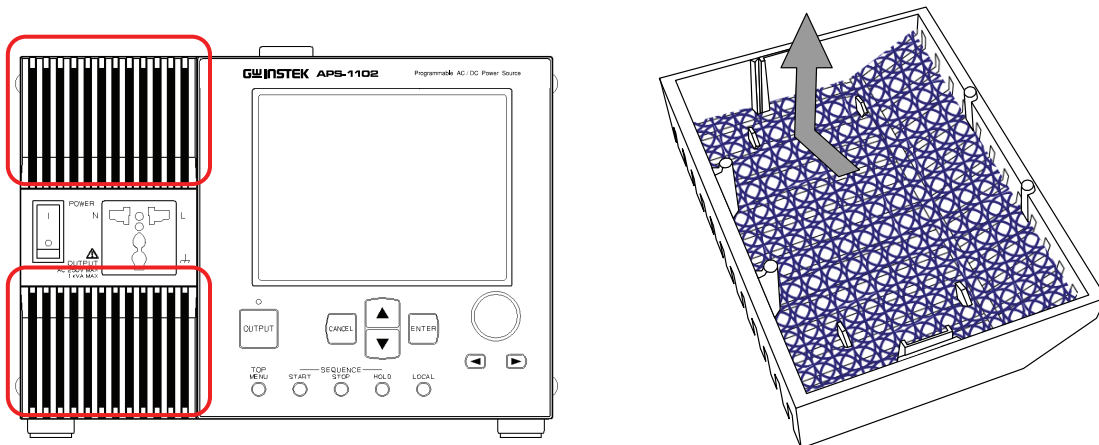

- (1) Press the back of the left side of the air inlet to the right and pull it.
- (2) The left side will be unhooked. Hold the left side and pull the inlet to the left forward to release it from the unit.
- (3) Take out the inside air filter from the back side of the inlet and clean it.
- (4) Perform steps (1) to (3) above to remove and clean the other air filter.
- (5) After the air filters are completely dry, perform steps (1) to (3) in reverse order to attach the air inlet covers.

Figure 8-1. Air Filter Cleaning Steps

The air filter will not function adequately if it becomes clogged, such as with very fine dust. To prevent this, do not install this device in a location where there is a lot of dust (or fine dirt, etc.). Also avoid humid locations where condensation occurs easily.

8.3 Storage, Repackaging, and Transport

Store the APS-1102 in a location that meets the installation requirements.

 See “2.2 Installation Environment”, for description of installation requirements.

a) Storage for long periods of non-use

- Remove the power cord from the outlet and the main unit.
- Store the main unit on a shelf or rack where it will be protected from airborne dirt and dust.
When it may be subjected to dust, cover it with a cloth or polyethylene sheet.
- The minimum storage environment requirements are a temperature range of -10°C to $+50^{\circ}\text{C}$, with 5% to 95% RH, but it is also important to avoid locations subject to abrupt temperature changes and/or exposure to direct sunlight. If possible, choose a storage environment that has a steady ambient temperature.

 See “9.16 Ambient Temperature Range, Ambient Humidity Range, Etc.”, for detailed storage conditions.

b) Repackaging and transport

Note the following caution points when repacking the main unit for transport, repair, or for some other reason.

- Wrap the main unit in a polyethylene bag or sheet.
- Use a cardboard box that is strong enough to support the main unit weight and large enough for its size.
- Pack with shock-absorbent material on all six sides of the main unit.
- Inform the transport company that this product is a high-precision machine.



8.4 Checking the Version Number

The APS-1102 firmware version is displayed in the bottom right of the screen for a few seconds after power-on.

At other times, the version information can be checked via the control panel system information screen, as described below.

■ Operation steps

Select the SYSTEM menu from the MISC menu , then select "INFORMATION".

1. Press the  or  key to move the cursor to the  icon.

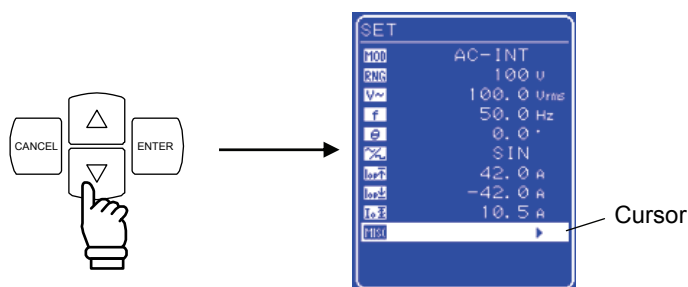

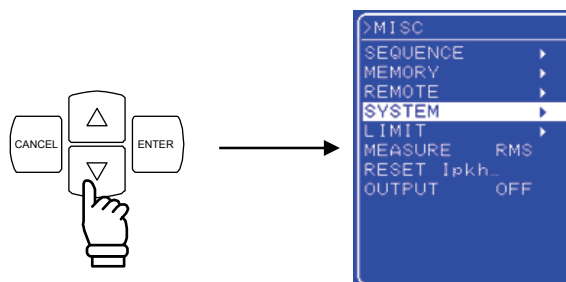

2. Press the  key to display the MISC menu.

Press the  key to move the cursor to "SYSTEM".

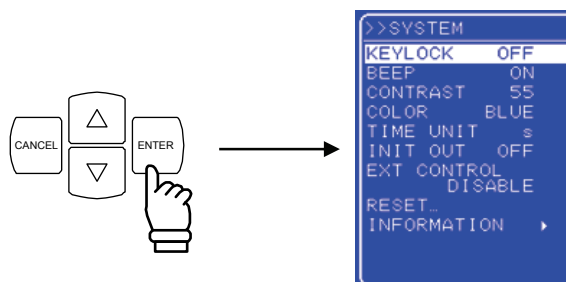

3. Press the  key to display the SYSTEM screen.



4. Press the  key to move the cursor to "INFORMATION".

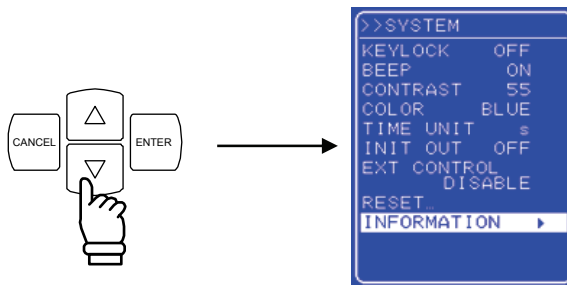

5. Press the  key to display the "SYSTEM INFORMATION" screen.

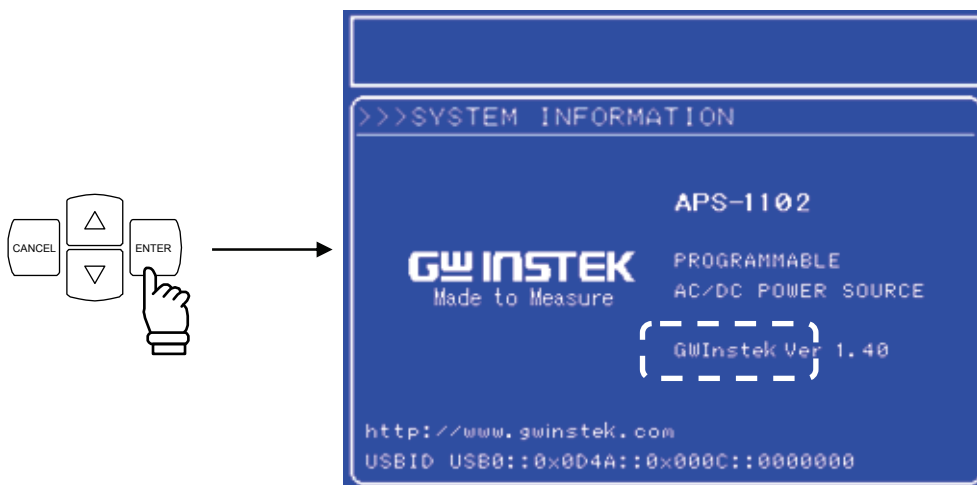
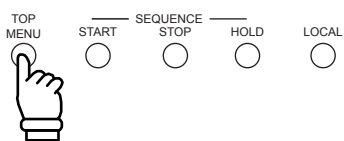

Figure 8-2. SYSTEM INFORMATION Screen

6. Press the TOP MENU key to return to the SET menu screen.



8.5 Backup Battery

The contents of memory ( See “4.8 Using Memory Functions”) and other required parameters and data are backed up by a lithium battery in the APS-1102.

The backup period varies according to the temperature and use conditions, but it is approximately five years when stored with the power off.

The backup data is checked at power-on, and an error message is displayed if the data has been corrupted ( See “7.2 Error Messages and Responses”), in which case the unit is reset to the initial values.

( See “4.8 Using Memory Functions”.)

The  icon will blink if the backup battery has been drained and the data has been lost.

In such cases, the battery must be replaced. Contact Good Will or an authorized distributor.

9. SPECIFICATIONS

9.1	Output	9-2
9.2	Current Limiter	9-6
9.3	Setting Range Limits	9-7
9.4	Signal Sources	9-8
9.5	Measurement Functions	9-10
9.6	Sequence Function	9-11
9.7	Arbitrary Waveform Memory	9-11
9.8	Setting Memory	9-11
9.9	Protection Functions	9-11
9.10	General	9-12
9.11	External Control I/O	9-13
9.12	USB Interface	9-13
9.13	Power Input	9-13
9.14	Withstand Voltage and Insulation Resistance	9-14
9.15	Ambient Temperature Range, Ambient Humidity Range, Etc.	9-14
9.16	External Dimensions and Weight	9-15
9.17	External Dimensions and Weight	9-15
9.18	EC Declaration of Conformity	9-17

Values with indicated accuracy are guaranteed values, and all other values are nominal values or typical (“Typ.”) values.

Unless otherwise noted, the following conditions are adopted:

Power input:	200 V AC, 50 Hz
Output mode:	AC-INT (alternate current - internal signal source) mode
Output frequency:	50 Hz
Output voltage:	100 Vrms (200 Vrms when in 200 V range)
Output waveform:	Sine wave
Load	100 V range: 10 Ω (power factor 1, nominal value) 200 V range: 40 Ω (power factor 1, nominal value)
Output terminals:	Terminal block on rear panel

9.1 Output

■ Output mode

All eight modes (combination of operation mode + signal source mode)

- AC-INT mode (alternate current - internal signal source)
- AC-EXT mode (alternate current - external signal source)
- AC-ADD mode (alternate current - internal + external source)
- AC-SYNC mode (alternate current - external synchronization)
- AC+DC-INT mode (direct current - internal signal source)
- AC+DC-EXT mode (direct current - external signal source)
- AC+DC-ADD mode (direct current - internal + external source)
- AC+DC-SYNC mode (direct current - external synchronization)

■ Output voltage ranges

100 V range and 200 V range

■ Maximum output power

750 VA (AC) / 750 W (DC)

Power supply input conditions: 100 V AC to 180 V AC input

(hereinafter referred to as “AC 100 V input system”)

Output voltage conditions: 130 Vrms (AC) / ± 183 V (DC) or lower (100 V range)

260 Vrms (AC) / ± 366 V (DC) or lower (200 V range)

1000 VA (AC) / 1000 W (DC)

Power supply input conditions: 180 V AC to 250 V AC input

(hereinafter referred to as “AC 200 V input system”)

Output voltage conditions: 135 Vrms (AC) / ± 190 V (DC) or lower (100 V range)

270 Vrms (AC) / ± 380 V (DC) or lower (200 V range)

■ Output terminals

Terminal block with M4 screws (rear panel)

AC receptacle (universal type, front panel)

Note: Use AC receptacle for AC (0 V AC to 250 V AC). When DC is included, use screw terminal block on rear panel.

■ Rated output

100 V range: 100 Vrms (AC) / 100 V (DC)

200 V range: 200 Vrms (AC) / 200 V (DC)

■ Output voltage settings

(When signal source mode is internal mode or internal + external mode, no load)

Note: The AC settings (peak value)+ DC setting that can be set are within the voltage setting limit range.

AC

100 V range: 0.0 to 140.0 Vrms

200 V range: 0.0 to 280.0 Vrms

Setting resolution: 0.1 Vrms

Setting accuracy: $\pm(0.5\% \text{ of set value} + 0.6 \text{ Vrms})$: 100 V range
 $\pm(0.5\% \text{ of set value} + 1.2 \text{ Vrms})$: 200 V range
 (AC mode, 50 Hz, 23 \pm 5°C)

DC

100 V range: -200.0 V to +200.0 V

200 V range: -400.0 V to +400.0 V

Setting resolution: 0.1 V

Setting accuracy: $\pm(|0.5\% \text{ of set value}| + 0.8 \text{ V})$: 100 V range
 $\pm(|0.5\% \text{ of set value}| + 1.6 \text{ V})$: 200 V range
 (AC+DC mode, 0 V AC setting, 23 \pm 5°C)

■ Maximum output current

100 V range: 10 Arms (AC) / 10 A (DC)

200 V range: 5 Arms (AC) / 5 A (DC)

Note 1: For the AC 100 V input system, the limit on the maximum output power may cause a reduction in the maximum output current.

Note 2: At or above the rated output voltage, the limit on the maximum output power reduces the maximum output current.

Note 3: When output frequency is 40 Hz or lower, or it is 400 Hz or higher, the maximum output current may decrease.

Note 4: The RMS value for AC + DC is within the maximum output current.

■ Maximum output peak current

100 V range: 40 Apk

200 V range: 20 Apk

Note 1: For the AC 100 V input system, the limit on the maximum output power may cause a reduction in the maximum output peak current.

Note 2: The above values are for a capacitor input type rectifier circuit whose crest factor is 4 or less.

Note 3: At or above the rated output voltage, the limit on the maximum output power may reduce the maximum output peak current.

Note 4: When output frequency is 40 Hz or lower, or it is 400 Hz or higher, the maximum output peak current may decrease.

Note 5: The peak value of AC + DC is within the maximum output peak current.

■ Frequency setting range

(When signal source mode is internal or internal + external mode only)

Setting range: 1.0 Hz to 550.0 Hz

Setting resolution: 0.1 Hz

Setting accuracy: ± 100 ppm (1.0 Hz to 550.0 Hz, 23 $\pm 5^\circ\text{C}$)

■ Phase when output is on

(When signal source mode is internal or internal + external mode only)

Setting range: 0.0° to 359.9°

Setting resolution: 0.1°

■ Output voltage waveform

(When signal source mode is internal or internal + external mode only)

Sine wave, square wave, arbitrary waveform (16 types)

■ Small amplitude frequency response

(When signal source mode is internal, 100 V range, output voltage is 20 Vrms, 50 Hz rating)

AC mode 40 Hz to 100 Hz: ± 0.5 dB

100 Hz to 550 Hz: +1 dB, -3 dB

AC+DC mode DC to 100 Hz: ± 0.5 dB

100 Hz to 550 Hz: +1 dB, -3 dB

■ Output voltage distortion factor

0.5% or less (50 Hz or 60 Hz)

■ Load regulation

0.5% or less (0 to 100%, via output terminal)

■ Line regulation

0.2% or less

(Power source input voltage is 100 V, 120 V, or 230 V, no load, rated output)

■ Output DC offset

100 V range: ± 50 mV or less

200 V range: ± 100 mV or less

(AC - INT mode, output voltage setting = 0 V)

9.2 Current Limiter

■ Output peak current limiter

When limiter is operating, output voltage is clipped.

Positive current setting range	100 V range: +10.0 A to +42.0 A (Initial value: +42.0 A)
	200 V range: +5.0 A to +21.0 A (Initial value: +21.0 A)
Negative current setting range:	100 V range: -42.0 A to -10.0 A (Initial value: -42.0A)
	200 V range: -21.0 A to -5.0 A (Initial value: -21.0 A)
Setting resolution:	0.1 A

■ Output average current limiter

When limiter is operating, suppresses output voltage.

Current setting range	100 V range: 1.0 A to 10.5 A (Initial value: 10.5 A)
	200 V range: 1.0 A to 5.3 A (Initial value: 5.3 A)
Setting resolution:	0.1 A

9.3 Setting Range Limits

When signal source mode is internal or internal + external only

■ Voltage setting limit

(Lower limit \leq upper limit)

Positive voltage setting range	100 V range: +5.0 V to +200.0 V (Initial value: +200.0 V)
	200 V range: +10.0 V to +400.0 V (Initial value: +400.0 V)
Negative voltage setting range	100 V range: -200.0 V to -5.0 V (Initial value: -200.0 V)
	200 V range: -400.0 V to -10.0 V (Initial value: -400.0 V)
Setting resolution:	0.1 V

■ Frequency setting limit

(Lower limit \leq upper limit)

Upper limit setting range:	1.0 Hz to 550.0 Hz (Initial value: 550.0 Hz)
Lower limit setting range:	1.0 Hz to 550.0 Hz (Initial value: 1.0 Hz)
Setting resolution:	0.1 Hz

9.4 Signal Sources

The signal sources that can be selected are internal (INT), external signal input (EXT), internal + external (ADD), and external synchronization (SYNC).

■ Internal signal source

(Internal source mode, internal + external source mode)

 See “9.1 Output”.

■ External signal input

(External signal source mode, internal + external source mode)

Gain setting range	100 V range: 0.0 to 200.0 times (initial value: 100.0)
	200 V range: 0.0 to 400.0 times (initial value: 200.0)
Gain setting resolution:	0.1
Gain accuracy:	±5% (50 Hz, gain is at initial value, with rated voltage output)
Output phase to input:	In-phase
Input terminal:	BNC connector (rear panel) (shared as external signal input terminal)
Input impedance:	10 kΩ
Input voltage range:	−2.2 V to +2.2 V
Nondestructive maximum input voltage:	±10 V
Frequency range:	DC to 550 Hz

■ External synchronization

(External synchronization mode)

Synchronization signal source:	External sync signal or line (select one)
Synchronization frequency range:	40 Hz to 500 Hz
Input terminal:	BNC connector (rear panel) (shared as external signal input terminal)
	* External sync signal is not required when line synchronization is selected
Input impedance:	10 kΩ
Input voltage threshold value:	TTL
Nondestructive maximum input voltage:	±10 V

9.5 Measurement Functions

■ Output voltage measurement

RMS value:	RMS value of AC+DC
Full scale:	225.0 Vrms: 100 V range 450.0 Vrms: 200 V range
Display resolution:	0.1 Vrms
Measurement accuracy:	±0.5% of the full scale (at 23 ±5°C)
Average value:	Average value of AC+DC (measures DC component)
Full scale:	±225.0 V: 100 V range ±450.0 V: 200 V range
Display resolution:	0.1 V
Measurement accuracy:	±0.5% of the full scale (at 23 ±5°C)
Peak value:	Positive peak voltage and negative peak voltage are displayed separately
Full scale:	+225 Vpk / -225 Vpk: 100 V range +450 Vpk / -450 Vpk: 200 V range
Display resolution:	1 Vpk
Measurement accuracy:	±3% of the full scale (at 23 ±5°C, sine wave)

■ Output current measurement

RMS value:	RMS value of AC+DC
Full scale:	15.00 Arms
Display resolution:	0.01 Arms
Measurement accuracy:	±1.0% of the full scale (at 23 ±5°C)
Average value:	Average value of AC+DC (measures DC component)
Full scale:	±15.00 A
Display resolution:	0.01 A
Measurement accuracy:	±1.0% of the full scale (at 23 ±5°C)
Peak value:	Positive peak current and negative peak current are displayed separately
Full scale:	+45.0 Apk / -45.0 Apk
Display resolution:	0.1 Apk
Measurement accuracy:	±3% of the full scale (at 23 ±5°C, sine wave)
Peak value hold:	+ peak current and - peak current maximum value
Full scale:	45.0 Apk
Display resolution:	0.1 Apk
Measurement accuracy:	±3% of the full scale (at 23 ±5°C, sine wave)

■ Output power measurement

Effective power

Full scale:	1200 W
Display resolution:	1 W
Measurement accuracy:	±2% of the full scale (at 23 ±5°C) (when output is 100 VA or above)

Apparent power: Calculated as output voltage RMS value × output current RMS value

Full scale:	1400 VA
Display resolution:	1 VA
Measurement accuracy:	±2% of the full scale (at 23 ±5°C) (when output is 100 VA or above)

Reactive power: Calculated as $\sqrt{(\text{apparent power})^2 - (\text{effective power})^2}$

Full scale:	1400 Var
Display resolution:	1 Var
Measurement accuracy:	±2% of the full scale (at 23 ±5°C) (when output is 100 VA or above)

■ Load power factor measurement: Calculated as effective power / apparent power

Measurement range:	0.00 to 1.00
Display resolution:	0.01

■ Load crest factor measurement: Calculated as (| positive peak current | and | negative peak current | maximum value) / RMS current

Measurement range:	0.00 to 50.00
Display resolution:	0.01

■ Output harmonic current measurement

(AC - INT mode only, fundamental wave is 50 or 60 Hz only)

Measurement range:	To 40th harmonic of fundamental wave
Full scale:	15 Arms and 100%
Display resolution:	0.01 Arms and 0.1%
Measurement accuracy:	1% of full scale at RMS value current (at 23 ±5°C, to 20th harmonic) ±1.5% of full scale at RMS value current (at 23 ±5°C, from 20th to 40th)

Note: This measurement does not comply with the IEC standards.

■ External synchronization frequency measurement

(external synchronization mode only)

Measurement range:	38.0 to 525.0 Hz
Display resolution:	0.1 Hz
Measurement accuracy:	±0.2 Hz (at 23 ±5°C, 50 or 60 Hz)

9.6 Sequence Function

Output parameters can be changed abruptly or swept in sequence.

Signal source is internal signal source only.

Sequence function settings are stored in memory with battery backup.

■ Number of sequences

1 sequence per operation mode (AC or AC+DC mode) and output range (100 V or 200 V)

■ Number of steps

1 to 255 (within 1 sequence)

■ Step time

0.1 ms to 999.9999 s (resolution 0.1 ms)

■ Operations within step

Constant, keep, or linear sweep

■ Parameters

DC voltage, AC voltage, frequency, waveform, and step synchronized output (2 bits)

■ Jump times

1 to 999 or continuous

■ Sequence control

Start: Starts a sequence.

Stop: Stops a sequence.

Hold: Maintains current step output. Restarted when a sequence is started.

Branch: Branches to the specified step.

9.7 Arbitrary Waveform Memory

The contents of arbitrary waveform memory are retained by battery backup.

- **Waveform memory count**

16

- **Waveform length**

4096 words

- **Waveform data**

15 bits

* Arbitrary waveform memory cannot be written to from the panel screen. USB interface is used for writing.

9.8 Setting Memory

Various settings are retained in memory with battery backup, and the settings when the power source was last turned off are restored at power-on. Among these various settings, the basic settings (output mode, output range, DC settings, AC settings, output current limiter, and setting range limits) can be stored in store/recall memory No. 1 to No. 30. These stored settings can be recalled.

The recall operation for store/recall memory can be executed only when output is off.

9.9 Protection Functions

- **Abnormal output**

When output overvoltage or output overcurrent is detected, output will be set to off and the error message is displayed.

- **Abnormal power source**

When an internal power source abnormality is detected, output will be set to off. Depending on the extent of the abnormality, all operations will become disabled except for the power-off operation.

- **Abnormal internal control**

When a control abnormality is detected, output will be set to off and all operations will become disabled except for the power shutdown operation. (In some cases, output will be set off but shutdown is not necessary.).

- **Abnormal internal temperature**

When an abnormality is detected, output will be set to off.

9.10 General

■ LCD settings

Contrast: Adjustable

Display color: Blue background or white background

■ Beep sound

On or off

When on, a beep sound will be output if a key input error or other operation error occurs. When a protection function-related error occurs, an alarm sound will be output regardless of the beep sound setting.

■ Keylock

On or off

When keylock is on, only the keylock off operation and the output off operation are enabled.

■ Output setting at power-on

On or off

When on, output is automatically set to on at power-on.

■ Reset function

This function resets all basic settings to their initial (factory) settings.

■ Self test function

This function checks memory at power-on.

9.11 External Control I/O

■ External control operation mode

Enabled or disabled (status output is continually output)

■ Control input

Input level	High level: +4.0 V or above, Low level: +1.0 V or below	
Nondestructive maximum input:	+10 V/-5 V	
Input impedance	+5 V pull-up with 47 k Ω	
Control item	Output off:	Output off at fall
	Output on:	Output on at fall
	Start sequence:	Start at fall
	Stop sequence:	Stop at fall
	Hold input:	Hold at fall
	Branch inputs 0, 1:	Start branch at fall

■ Status output

Output level	0/+5 V (open)	
Output impedance	100 Ω	
Status items	Power source on/off status:	0-off, 1-on
	Output on/off status:	0-off, 1-on
	Limiter operation:	0- Not operating, 1- Operating
	Software busy:	0- Normal, 1- Busy
	Sequence operation step synchronized outputs 0 and 1	

■ Terminals

D-sub 25-pin multi-connector (rear panel)

9.12 USB Interface

USB interface is provided to enable control from an external computer.

Interface standard: USBTMC

9.13 Power Input

Input voltage range:	100 V AC to 230 V AC \pm 10% (not exceeding 250 V) Overvoltage Category II
Frequency range:	50 Hz or 60 Hz \pm 2 Hz (single phase)
Power consumption:	1.4 kVA or less
Power factor:	0.95 or above (during 100 V AC input)
	0.90 or above (during 200 V AC input)
Protective ground impedance:	0.1 Ω or less (not including the power cord set)

9.14 Withstand Voltage and Insulation Resistance

Between input power line vs. output/case or input power line/case vs. output

■ Withstand voltage

1500 V AC

■ Insulation resistance

30 M Ω or above, 500 V DC

9.15 Safety and EMC Compliance

(Only Models with a CE Marking on the Rear Panel)

■ Safety

Compliant with the following standard requirement

- EN61010-1:2001

Class I

Pollution Degree 2

■ EMC Compliance

Compliant with the following standard requirement

- EN61326-1: 2006 (Class A)
- EN 61000-3-2: 2000+A2:2005
- EN 61000-3-3: 1995+A1: 2001 +A2: 2005

9.16 Ambient Temperature Range, Ambient Humidity Range, Etc.

Operating environment:	Indoor use
Altitude:	2000 m or lower
Operation guarantee:	0 to +40°C/5 to 85% RH When absolute humidity is 1 to 25 g/m ³ , with no condensation
Performance guarantee:	+5 to +35°C, 5 to 85% RH When absolute humidity is 1 to 25 g/m ³ , with no condensation
Storage condition:	-10 to +50°C, 5 to 95% RH When absolute humidity is 1 to 29 g/m ³ , with no condensation

Figure 9-1 shows the ambient temperature and humidity ranges.

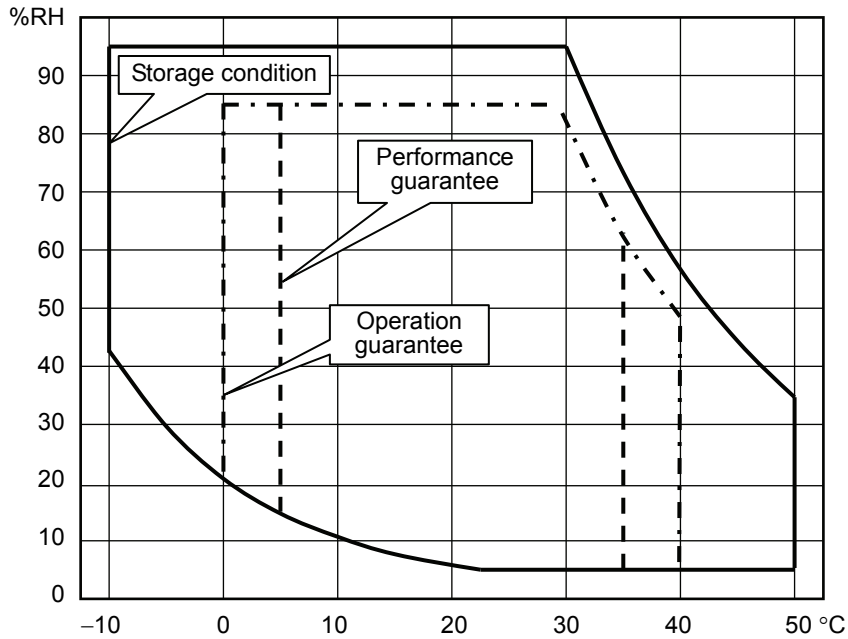

Figure 9-1. Temperature and Humidity Ranges

9.17 External Dimensions and Weight

■ External dimensions

Width: 258 mm

Height: 176 mm

Depth: 440 mm

(Projections are not included.)

■ Weight

Approximately 9.5 kg

Figure 9-2 shows the external dimensions.

9.18 EC Declaration of Conformity

We
GOOD WILL INSTRUMENT CO., LTD.
 (1) No.7-1, Jhongsing Rd., Tucheng City, Taipei County, Taiwan
 (2) No. 69, Lu San Road, Suzhou City (Xin Qu), Jiangsu Sheng, China
 declare, that the below mentioned product

Type of Product: **PROGRAMMABLE AC/DC POWER SOURCE**
 Model Number: **APS-1102**

are herewith confirmed to comply with the requirements set out in the Council Directive on the Approximation of the Law of Member States relating to Electromagnetic Compatibility (2004/108/EC) and Low Voltage Directive(2006/95/EC) .
 For the evaluation regarding the Electromagnetic Compatibility and Low Voltage Directive, the following standards were applied:

© EMC

Electrical equipment for measurement, control and laboratory use— EMC requirements (2004/108/EC)	
Harmonized Standard	EN 61326-1: 2006
Conducted & Radiated Emission CISPR11:2004 Class A	Electrostatic Discharge EN 61000-4-2: 1995+A1:1998+A2:2001
Current Harmonics EN 61000-3-2: 2000+A2:2005	Radiated Immunity EN 61000-4-3: 2006
Voltage Fluctuations EN 61000-3-3: 1995+A1: 2001 +A2: 2005	Electrical Fast Transients EN 61000-4-4: 2004
-----	Surge Immunity EN 61000-4-5: 1995+A1:2001
-----	Conducted Susceptibility EN 61000-4-6: 1996+A1: 2001
-----	Power Frequency Magnetic Field EN 61000-4-8: 1993 + A1: 2001
-----	Voltage Dip/ Interruption EN 61000-4-11: 2004

© Safety

Low Voltage Equipment Directive 2006/95/EC	
Safety Requirements	EN 61010-1: 2001